

# FRAME\_S BOARD

Mobile FRAME\_S Boards (with castors) enable you to restructure open space in new ways whenever desired. They also facilitate the integration of work tools, such as flip charts and whiteboards, into a setting. This makes them not just room dividers but also analogous writing, work and presentation boards. There are two typologies available; the T-Type and Type. When equipped with PIXEL

supports the H-Type can be used to store and porter up to 20 PIXEL Boxes, 4 PIXEL 180 Tops and several PIXEL Tops and Pads. With PIXEL, the FRAME\_S Boards combine to create temporary and flexible room structures that can quickly be reorganised. This makes it possible to respond immediately to various needs, for example during a workshop.



**bene**

INSPIRING OFFICES. SINCE 1790.

## PRODUCT DESCRIPTION

- ❶ **Frame:** Metal frames consisting of two half sections.  
Height 1.734,5 mm and width 860 mm  
Surface: white, powder-coated
- ❷ **Dividing wall:** Widths 1.621 mm (FRAME\_S Board T-Type)  
or 1.821 mm (FRAME\_S Board H-Type)  
Surface: Melamine, MW white
- ❸ **Base set:** Base set consisting of 4 or 3 castors with brake depending on type/plastic, white
- ❹ **Cover profile:** (with organisation profile below)

FRAME\_S Board, H-Type

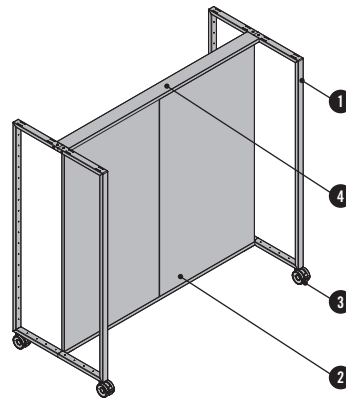

FRAME\_S Board, T-Type

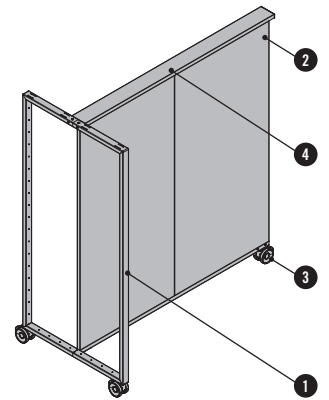

## OVERVIEW & DIMENSIONS

FRAME\_S BOARD, H-TYPE

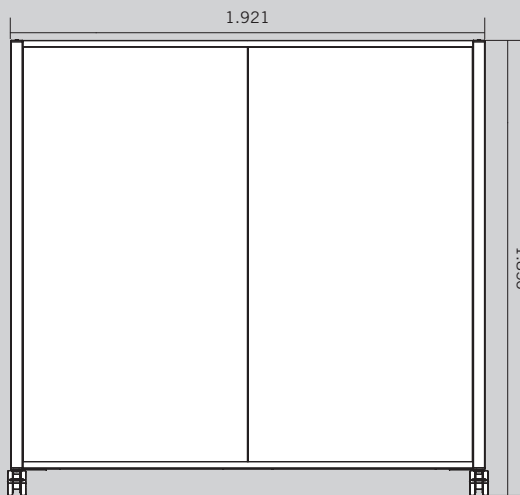

FRAME\_S BOARD, T-TYPE

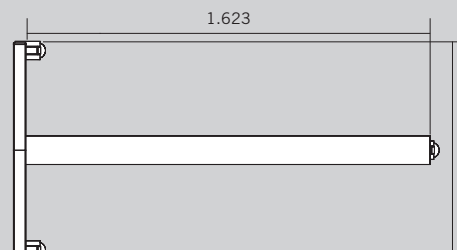
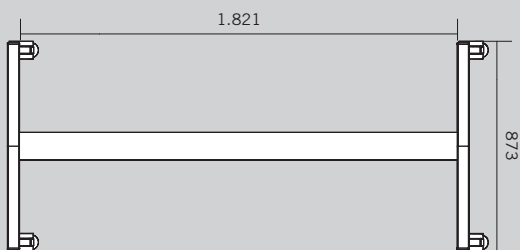
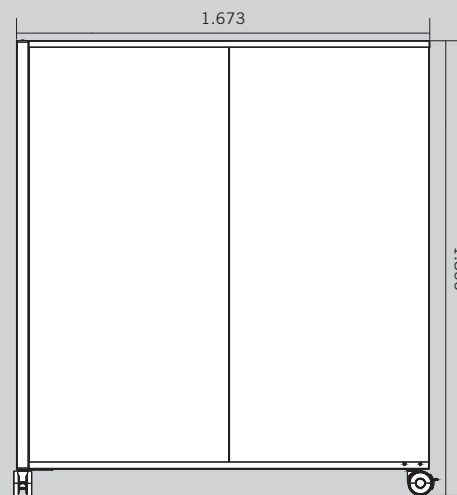

Measurements in mm

## OPTIONS

### WHITEBOARD (MAGNETIC)

For hooking into the organisation profile.  
Dimensions: Width 806 mm, height 1.071 mm and thickness 4 mm.  
Material and colour: W1 white, powder-coated

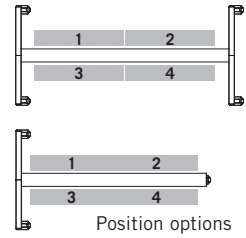
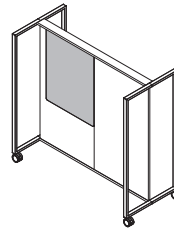

### PINBOARD

For hooking into the organisation profile.  
Dimensions: width 806 mm, height 1.071 mm and thickness 12 mm.  
Covers are available in the fabric groups P0-P4 (Inn), per Bene seating furniture collection.

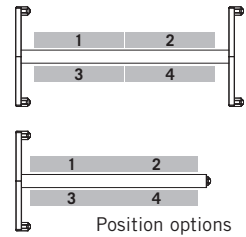
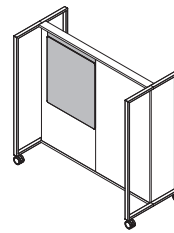

### FLIP CHART - PAD HOLDER

A flip chart - pad holder (magnetic) is available as an additional option, although it can only be used in combination with a whiteboard or pinboard.

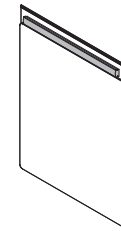
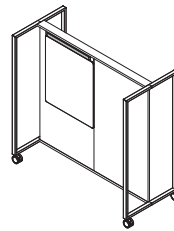

### SCREEN ASSEMBLY

The following are required in order to assemble a screen:

- Assembly set for TFT wall-mounted bracket
- Wall-mounted bracket "CHIEF RMF 2"
- a screen compatible with the wall-mounted bracket, max. 56 kg (optimised for "NEC MultiSync LCD ME431, ME501, ME551, ME651, WD551")

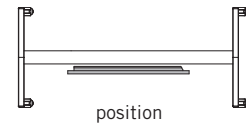
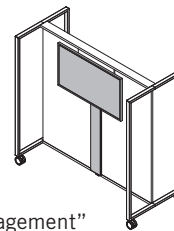

Further info on connection plug board and cables → Price list "Cable and media management"  
Further info on wall-mounted bracket and screen → Price list "Media hardware"

### PIXEL CARRIER(S)

Steel frames are attached to the frame without tools and offer storage for 10 PIXEL Boxes and 2 of the PIXEL Top 180 per side.

Please note:  
The following options are not available if a PIXEL support is used.

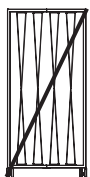
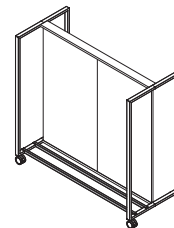

Version 1

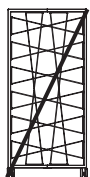

Version 2

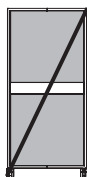

Complete visual screening

# OPTIONS

## FRAME APPLICATIONS

### Railing

The frame features rows of shelving holes, which allow the integration of frame applications. A core element here is the railing, which consists of an aluminium profile and can be used for organisation and screening. Material and colour: aluminium W1 white, powder-coated

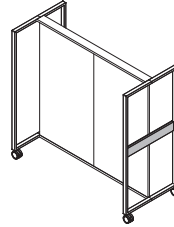

### Partial visual screening

Partial visual screening elements can be integrated into the railing in the frame. This partial visual screening here can be optionally made from chipboard (8 mm) in basic and décor colours or from perspex (6 mm). In addition to perspex with a white satin finish, a clear smoked glass version is optionally available.

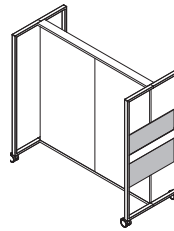

### Complete visual screening at top & bottom

Complete visual screening made of chipboard (8 mm) or perspex (6 mm) is also possible above the railing - in its actual application this seems useful in combination with shielding at bottom. Here, too, basic and décor colours are available for the chipboard, as well as perspex in a white satin finish or clear smoked glass.

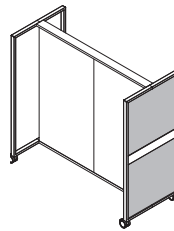

### Decorative elastic cord

A decorative elastic cord can be clamped into the rows of shelving holes in the frame by using small hooks. Different patterns are available for the FRAME\_S Board frame and it can also be adjusted individually.

Version 1

Version 2

Version 3

Version 4

Wire hooks for attaching the cord

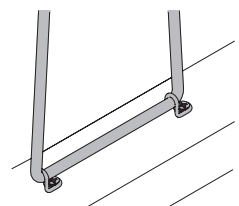
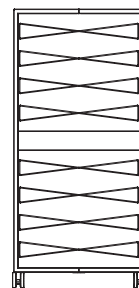
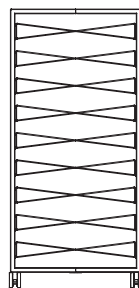
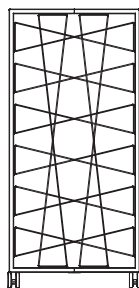
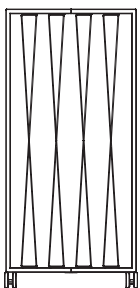

## SAFETY INSTRUCTIONS

Use of PIXEL supports in FRAME\_S Board H-Type  
10 PIXEL Boxes per side / total max. 20 PIXEL Boxes

Maximum load: 200 kg

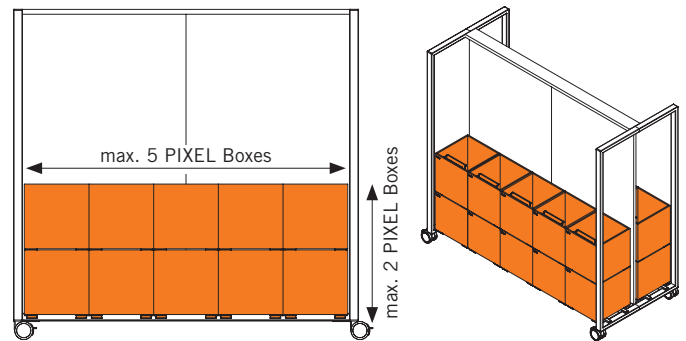

Place the PIXEL Boxes on top of each other correctly!

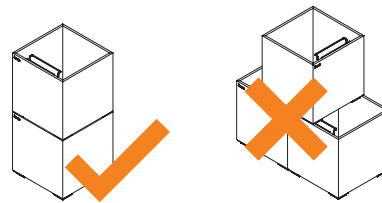



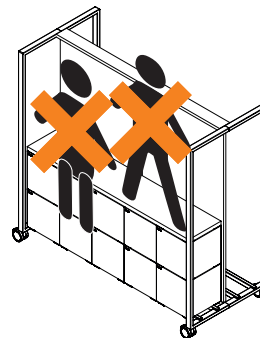



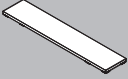

Do not sit or stand on them!



## INSPIRATIONS

**INSPIRATION #01**  
approx. 25 m<sup>2</sup>/approx. 4 - 6 persons

12x .....		3x .....		2x .....		1x .....	
4x .....		5x .....					
4x .....		2x .....		2x .....		1x .....	

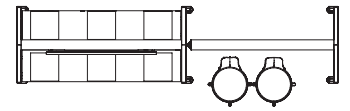

### DISCOVER



### CREATE

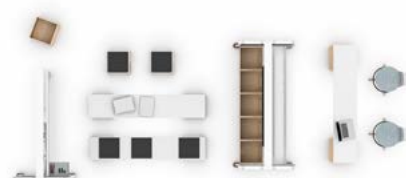

### SHARE



## INSPIRATIONS

### INSPIRATION #02

approx. 20 m<sup>2</sup>/approx. 2 - 4 persons

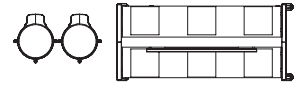
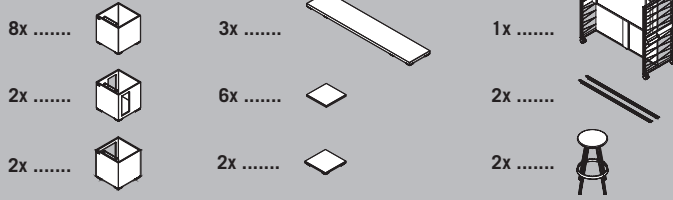

### DISCOVER



### CREATE



### SHARE



## COLOURS & MATERIALS

### MELAMINE: Basic colours

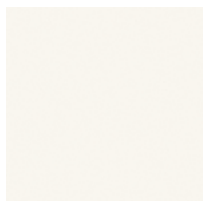

MW blanc



Various fabric collections are available for the cover: Era, Urban Plus, Xtreme Plus, Inn, Step, Step Melange, Remix, Europost, Mainline Flax, Assam, Steelcut, Fiord, Hallingdal, Steelcut Trio, Divina Melange, Divina MD, Coda, Elle.  
More information about the specific fabric collections is available at [www.bene.com](http://www.bene.com).