

FRAME_S

FRAME_S is an intelligent workplace system that serves to give structure to open spaces. It offers its user the privacy of an individual shielded work bay, whilst making it easier to define team areas. Comprising of metal frames and storage elements, FRAME_S can be combined with Bene desks to form well-organised workstations. The frame is a formative

and striking design which can be heightened further with additional design options and integrated frontal storage. Its characteristic screening design enables the user to create team zones using additional meeting furniture that is directly connected to the personal workspace; the whole space becomes a team zone encouraging communication and cooperation.



PRODUCT DESCRIPTION

- ① Dividing wall
- ② Tall cabinet lower cabinet
- ③ Tall cabinet upper cabinet
- ④ Frame
- ⑤ Box
- ⑥ Covered side
- ⑦ Cover profile (below organisation profile)
- ⑧ **Table:** T-Workstation, T-Lift Desk and Lift Desk Pure can be used here. Widths from 1.200 - 1.800mm.

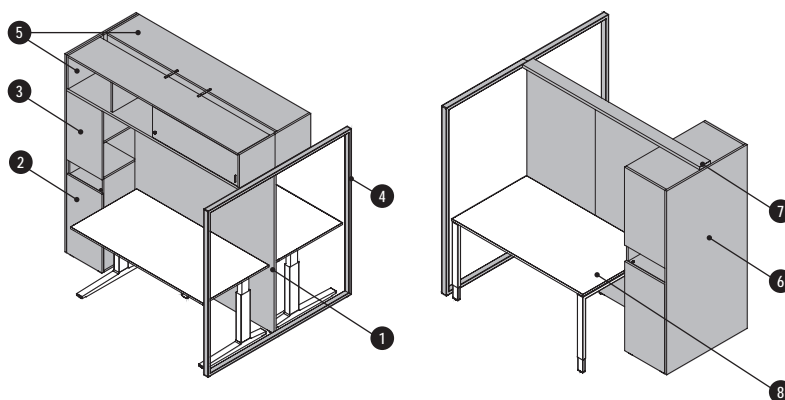

FRAME

The metal frame is made up of two half sections. There are three different frame section widths available, but all in one height.
Surface: white, powder-coated

Frame variants

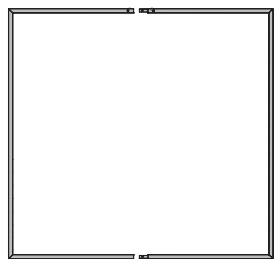

H= 1.735 mm W= 1.735 mm

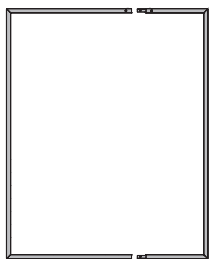

H= 1.735 mm W= 1.297,5 mm

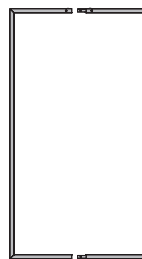

H= 1.735 mm W= 860 mm

CONFIGURATION OPTIONS/ MODULARITY

with box



2 workspaces

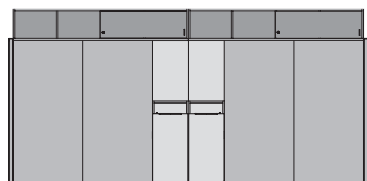

4 workspaces, mirrored

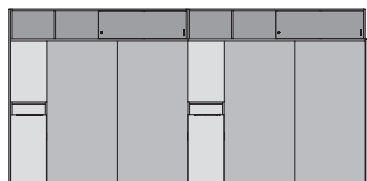

4 workspaces
arranged in a row

without box

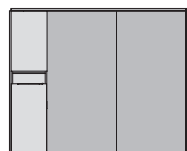

2 workspaces

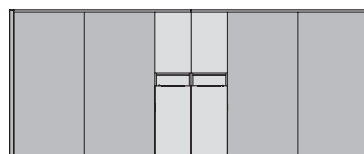

4 workspaces, mirrored

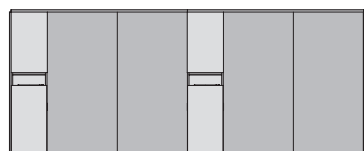

4 workspaces
arranged in a row

OVERVIEW & DIMENSIONS

ADJUSTED FOR TABLE WIDTH 1.200 MM

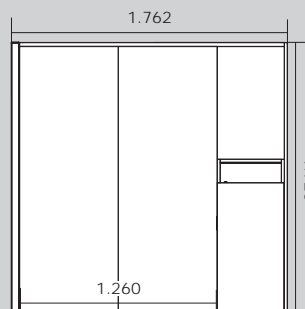
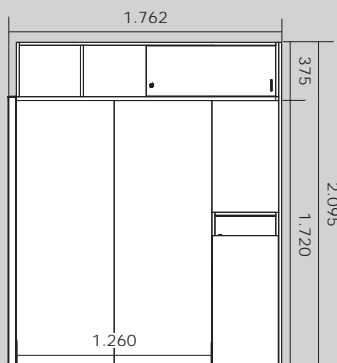

ADJUSTED FOR TABLE WIDTH 1.400 MM

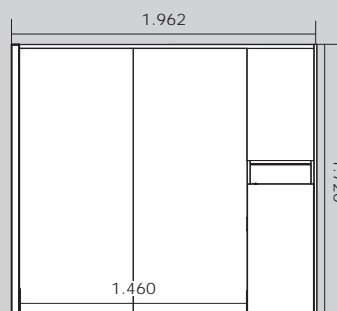
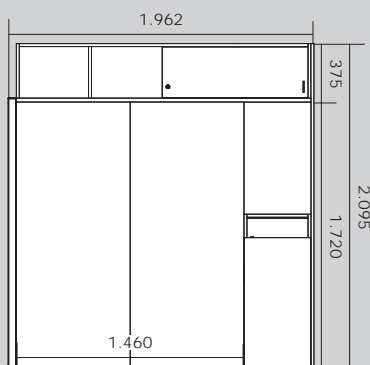

ADJUSTED FOR TABLE WIDTH 1.600 MM

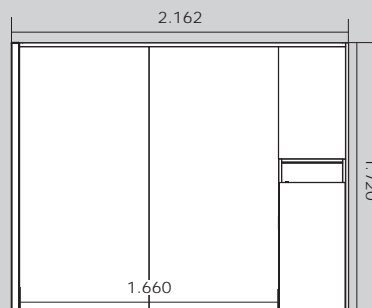
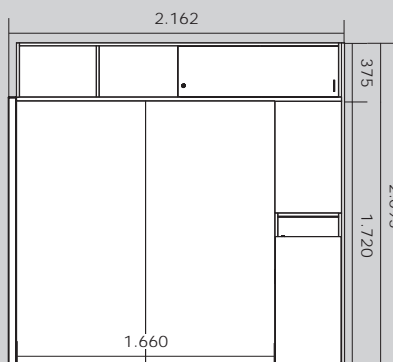

ADJUSTED FOR TABLE WIDTH 1.800 MM

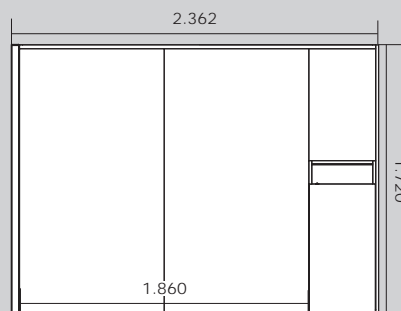
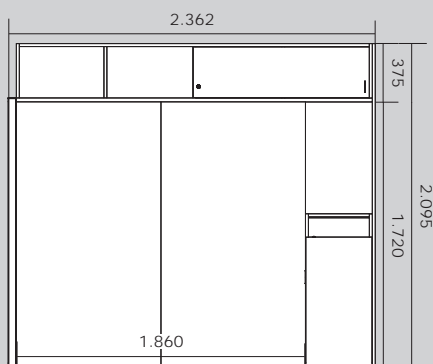

Dimensions in mm

OPTIONS

TOP COVER PROFILE (DIVIDING WALL)

The cover neatly hides the profile of settings configured without a top storage box. Material and colour: Aluminium WI white, powder-coated

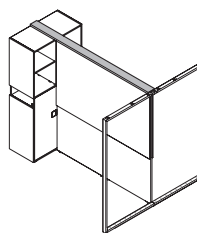

FABRIC PANEL

The fabric panel is attached to the organisation profile and can therefore be upgraded easily.

Covers are available in the fabric groups P0-P4, as per Bene seating furniture collection.

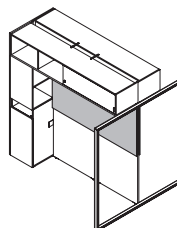

WHITEBOARD

A magnetic whiteboard is available in two different sizes, depending on where it is attached to on the system.

High whiteboard: 1.096 x 856 mm (on covered side)

Low whiteboard: 721 x 856 mm (in front on two tall cabinets)

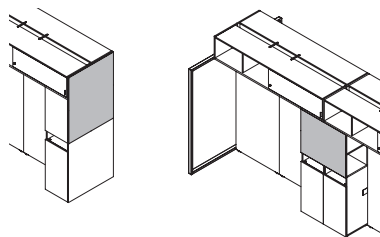

TALL CABINET LOWER CABINET

Accessory tray

An accessory tray can be optionally selected in the lower cabinet of the tall cabinet. Material and colour: Plastic, SZ black

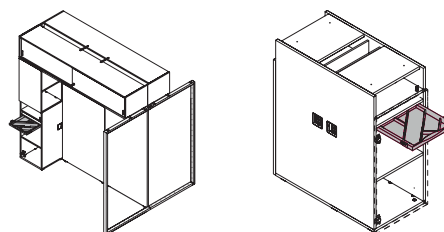

Cabling intermediate bottom - connection plug board

A connection plug board can be optionally integrated into the lower half of the tall cabinet. Cabling is neatly channeled out of sight within the structure of the tall cabinet

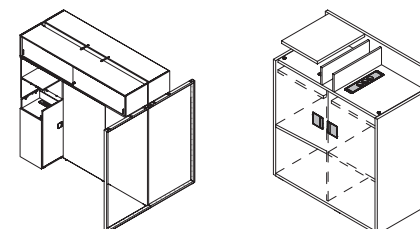

Lock

Cylinder lock

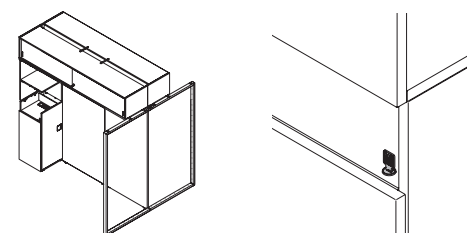

OPTIONS

FRAME APPLICATIONS

The frame features rows of shelving holes, which allow the integration of frame applications. A core element here is the railing, an aluminium profile that can be used for organisation and screening. The railing is primarily meant for use in the large frame.

Material and colour: Aluminium W1 white, powder-coated

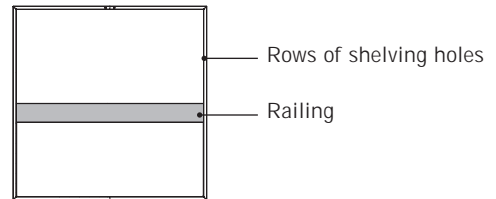

Partial visual shielding

Partial visual shielding elements can be integrated into the railing in the large frame. This partial visual screening can be made from chipboard (8mm) in basic and décor colours or from perspex (6mm). Perspex can be specified with a white satin finish, or as clear smoked glass.

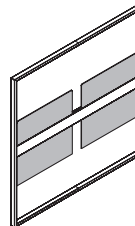

Complete visual shielding at bottom

Comparable to the partial visual shielding, a complete visual shielding made of chipboard or perspex is also possible. Chipboard is only available at 25 mm thick. Perspex, in white satin finish or clear smoked glass, is always 6 mm thick.

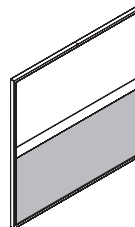

Complete visual shielding at top & bottom

Complete visual shielding made of chipboard (8mm) or perspex (6mm) is also possible above the railing - it is advised to combine this with shielding on the bottom half for aesthetic reasons. Here, too, basic and décor colours are available for the chipboard, as well as perspex in a white satin finish or clear smoked glass.

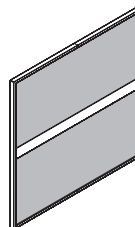

Decorative elastic cord

A decorative elastic cord can be clamped into holes integrated in the frame, otherwise used for shelving, with small hooks. Three patterns are available for large and mid-sized frames; however, the cord can also be clamped individually. Integration is also possible in small frames.

Version 1

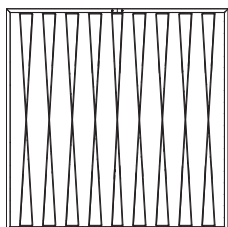

Version 2

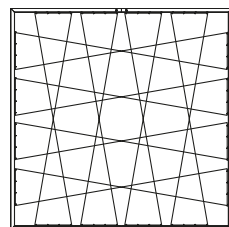

Version 3

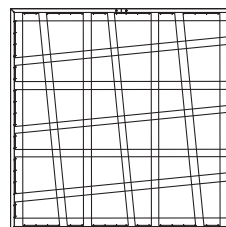

Wire hooks for rope attachment

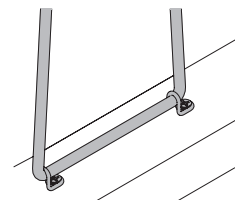

Pleated blind

Temporary and spontaneous shielding towards a hallway or window is possible with a pleated blind that can be integrated into the large frame.

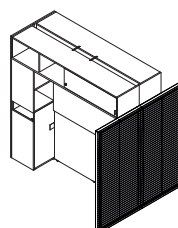

COLOURS & MATERIALS

All fabric collections are available as cover:

Urban Plus, Xtreme Plus, Inn, Step, Step Melange, Remix, Europost, Field, Clara, Divina, Steelcut, Hallingdal, Steelcut Trio, Divina Melange, Divina MD, Greenwich Uni. More information about the specific fabric collections is available at www.bene.com.