

# CONSULT

The elegant connection of work and discussion. CONSULT offers the perfect foundation for conveying a professional appearance: the spacious work desk system elegantly combines desk, storage and meeting area into one piece of furniture.

On one hand it is a place for focused working, while also a space for informal exchange, expert consultations and successful negotiations on the other. CONSULT conveys identity and looks inviting – making anyone feel that they are in good hands.



**bene**

INSPIRING OFFICES. SINCE 1790.

## PRODUCT DESCRIPTION

- 1 **Table Top:** Three board thickness are available:  
13 mm compact top, 19 mm, or 25 mm chipboard
- 2 **Edge (circumferential):** Chipboard 19 mm: 2 mm mono-edge or 3 mm mono-edge. Chipboard 25 mm: 2 mm mono-edge or 3 mm mono-edge.
- 3 **Frame:** Circle
- 4 **KT Sideboard**

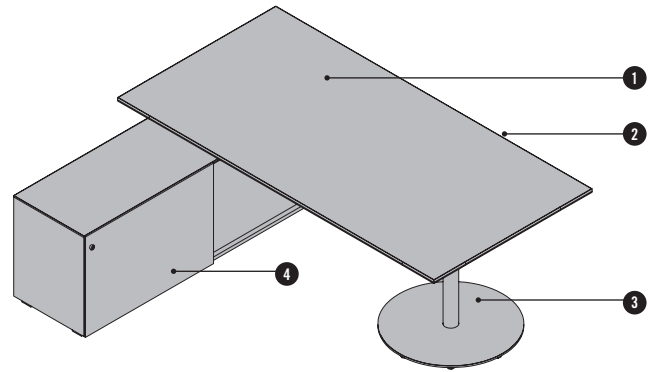

## OVERVIEW AND DIMENSIONS

### DESKTOP SHAPE TG BASIC DESK

#### Angled desk 150° W5

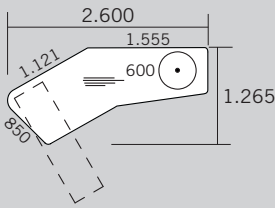

#### Angled desk 150° two-part W6

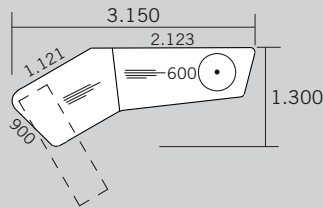

#### LEGEND

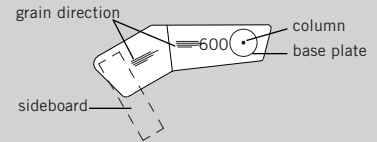

All shown top shapes in left adjustment.

### DEFINITION OF DESK SIDES/TOP SHAPE DIRECTION

#### W5, W6

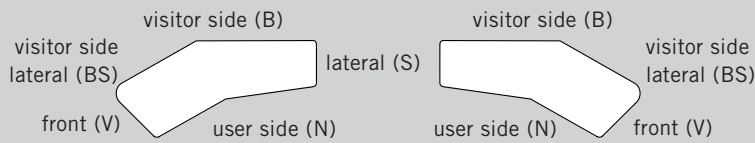

Dimensions in mm

## FRAME VERSIONS

### CIRCLE

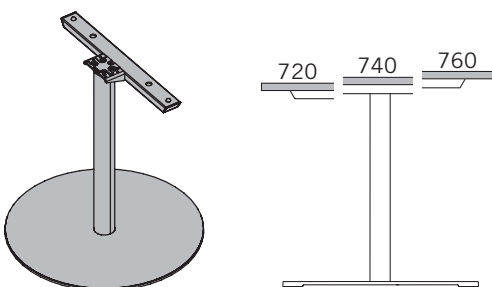

- Round pipe Ø 70 mm, smooth steel pipe
- powder-coated, sleeve anodised
- W1 white, AL aluminium anodised, SZ black
- Levelling: +10 mm by means of adjustment leg
- Range of height adjustment: 720/740/760 mm fixed
- Console is always in AL aluminum, coloured

## OPTIONS

### FOLDABLE CABLE TRAY T

- quick and easy cable management under desk top
- positions are always predefined and not changeable
- colour: SZ black

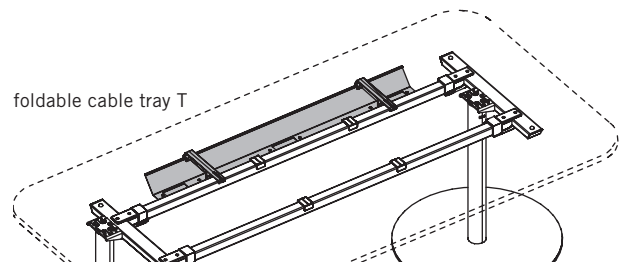

#### Possible positions of the cable tray

W5

W6

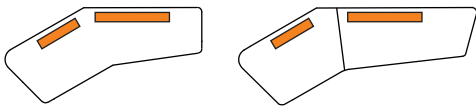

### PLUGBOX

- positions are pre-defined and not changeable
- 1 to maximum 2 plugboxes per desk top are possible
- plugbox is always integrated flush to the desk top

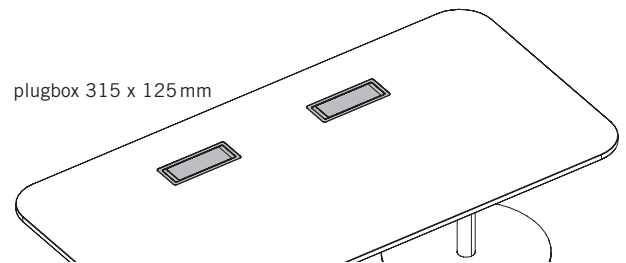

#### Possible positions of the plugbox

W5

W6



Plugbox and possible connection plug boards → pricelist cable and media management.

### GROMMET HOLE

- positions are pre-defined and not changeable
- 1 to maximum 3 grommet holes per desk top are possible
- colour (coloured): WI white, AL aluminium or SZ black with covering

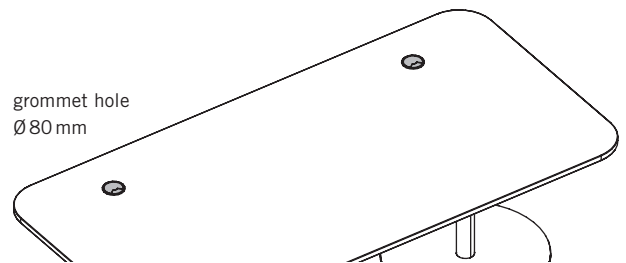

#### Possible positions of the grommet hole

W5

W6



#### Designations of positions

L...left, R...right, BS...visitor side lateral, B...visitor side, V...front, E...corner, S...lateral

## OPTIONS

### PREPERATION FOR CONNECTION T-PANEL EXTEND, RV DIVIDING WALL & ACCESSORIES (UNIVERSAL ADAPTER)

- elements only at the top shapes W4, W5 and W6 possible
- fixed on univaler adapters
- number of the univaler adapters depends on top shape and top width and is always analog to the number of the top
- connection of T-Panel and shortend panels is not possible

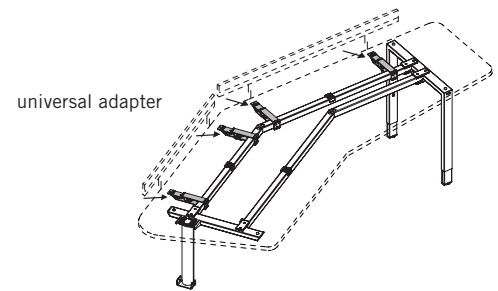

### SIDEBOARD CONNECTION

- sideboard is used as a slab-end replacement
- connection is integrated at Consult standardly
- maximum one sideboard per desk
- top shapes W5, W6: min. width of the sideboard is 1.600mm
- desk height adjusted mechanically in 20mm of grid (650 - 850mm)

further information of sideboard → price list KT Sideboard

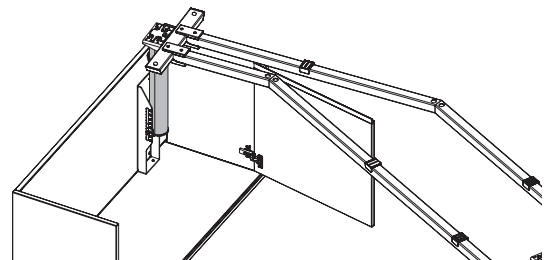

### Possible positions and inserting angles of the sideboard

W5

W6

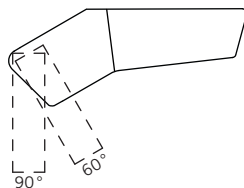
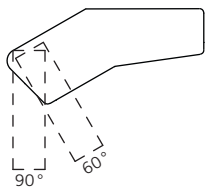

## INSPIRATIONS



### Inspiration #01

- Consult with Circle
- Angled desk 150° two-part W6, 3.150 x 1.300 mm
- Top colour: CO coco, column colour: WI white
- KT Sideboard in MW white and CO coco
- 1x B\_Run (PO) and 2x Dexter (PO)

## COLOURS & MATERIALS

### MELAMINE GROUP 1: Basic colours

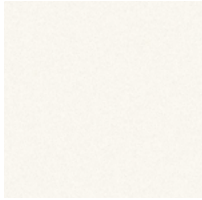

MW white

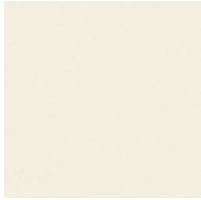

MQ office white



MC canvas<sup>2</sup>

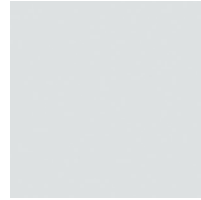

MP platinum<sup>2</sup>

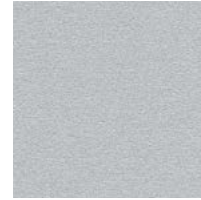

MA aluminium<sup>2</sup>



MS slate<sup>2</sup>

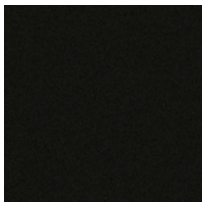

MB basalt

### MELAMINE GROUP 2: Additional basic colours<sup>1,2</sup>



MH stone grey

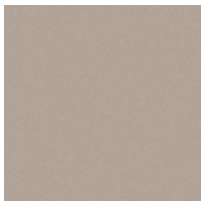

TM clay



MD urban grey

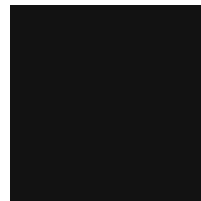

MGS graphite black



MSW snow white

### MELAMINE GROUP 2: Decor colours<sup>1,2</sup>



AR maple



EZ oak vicenza



BH beech light



NG walnut grey

### MELAMINE GROUP 3: Accent colours<sup>1,2</sup>



MPZ pistachio



MHR light rose

### MELAMINE GROUP 3: Decor colours, wooden texture<sup>1,2</sup>



CO coco texture



MNP walnut pavia

<sup>1</sup> not available for compact top

<sup>2</sup> not available for 3 mm edge single-coloured

## COLOURS & MATERIALS

### VENEER: Maple



AK canad. maple

### VENEER: Beech



BG beech, grey

### VENEER: Oak



EY oak, silt

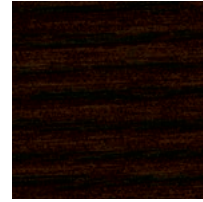

ER oak, amaretto

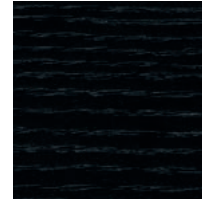

EV oak, volcano



EG oak grey

### VENEER: Chestnut



KD chestnut natural



KP chestnut brown



KQ chestnut grey

### VENEER: Walnut

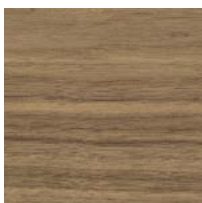

NF americ. walnut

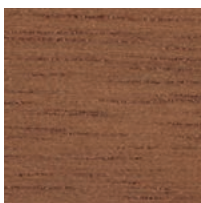

NR walnut, sienna

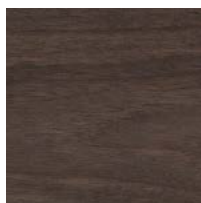

NB walnut, umbra

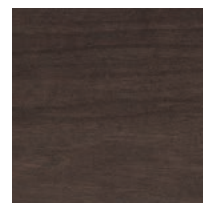

NA wal., anthracite

### VENEER: Bamboo



BJ bamboo

### METAL SURFACE POWDER-COATED

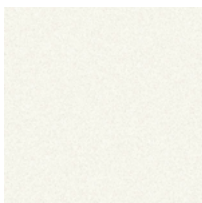

WI white

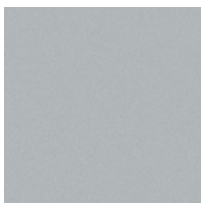

AL aluminium



SZ black

### ALUMINIUM ANODISED

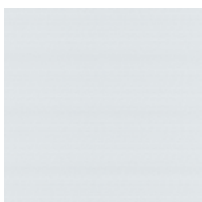

AL aluminium