

STUDIO

Dimensions and Colours

Dimensions et finitions

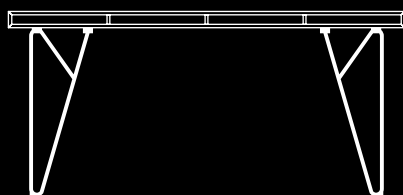

bene

STUDIO

COLOURS & MATERIALS COULEURS ET MATERIAUX

TABLETOP & FRONTS PLAN DE TRAVAIL & FAÇADES

MELAMINE
MELAMINE



MW WHITE
BLANC



MS SLATE
ARDOISE



MB BASALT
BASALTE

VENEER*
EBENISTERIE*



EY OAK SYLT
CHENE SYLT

FENIX NTM®
FENIX NTM®



FENIX BLACK
FENIX NOIR

TABLE LEGS & CONNECTIVE ELEMENTS PIETEMENT & PIECES DE CONNEXION

STRUCTURED POWDER COATING
REJETEMENT THERMOLAQUE STRUCTURE



WI WHITE
BLANC



SZ BLACK
NOIR

* For meeting table top, double doors, shelf bottoms, shelving units
* Plateau de la table de réunion, portes à battant, étagère, surface de dépose

STUDIO DESKSYSTEM

FRAME OPTIONS OPTIONS DE PIETEMENT

SWING

STUDIO SWING
WITH DOUBLE TOP
STUDIO SWING AVEC
DOUBLE PATEAU

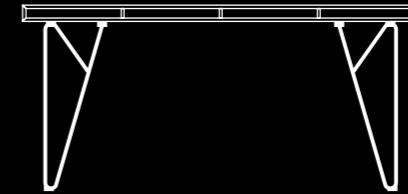

STUDIO SWING
WITH SINGLE TOP
STUDIO SWING AVEC
PATEAU SIMPLE

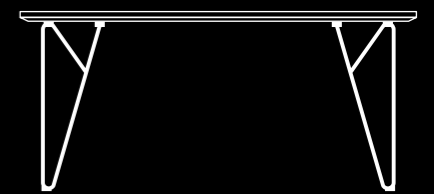

FACT

STUDIO FACT
WITH DOUBLE TOP
STUDIO FACT AVEC
DOUBLE PATEAU

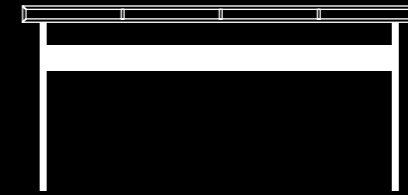

STUDIO FACT
WITH SINGLE TOP
STUDIO FACT AVEC
PATEAU SIMPLE



TABLETOPS & EDGES PLANS DE TRAVAIL & CHANTS

DOUBLE TOP
DOUBLE PATEAU

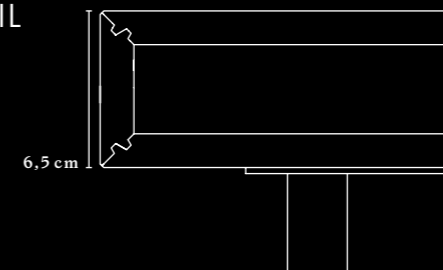

6,5 cm

SINGLE TOP
PATEAU SIMPLE

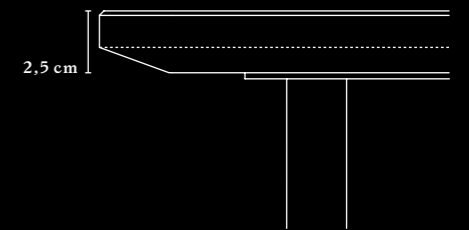

2,5 cm

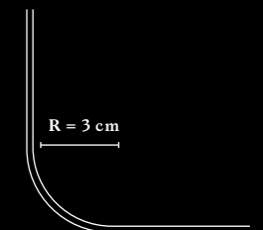

R = 3 cm

OVERVIEW & DIMENSIONS

APERÇU & DIMENSIONS

WORKTABLE

PLAN DE TRAVAIL

Table height 75 cm
Hauteur du plan de travail 75 cm

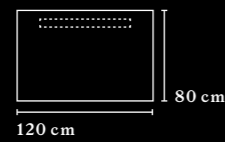
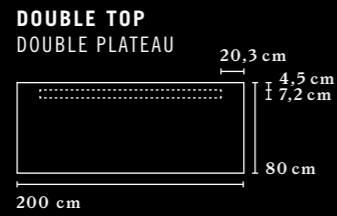

Worktables with a Double Top can be fitted with an optional organisation board.
Dans les plans de travail à double plateau, une Dock Station peut être intégrée.

MEETING TABLE

TABLE DE REUNION

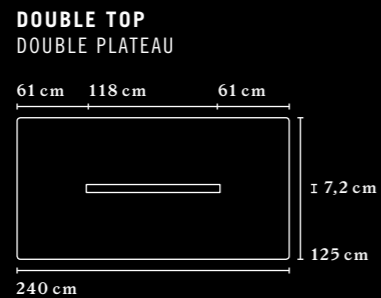

Meeting tables are only available with the Double Top and are always fitted with an organisation board.
Les tables de réunion sont toutes dotées d'un double plateau et contiennent toujours une Dock Station.

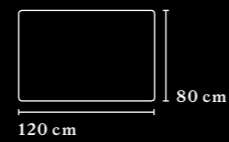
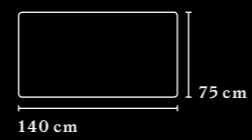
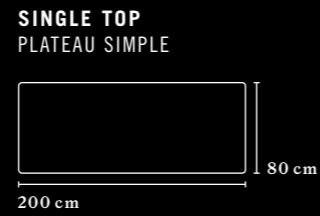

STUDIO SHELVING SYSTEM

OVERVIEW & DIMENSIONS

APERÇU & DIMENSIONS

CONSTRUCTION

MONTAGE

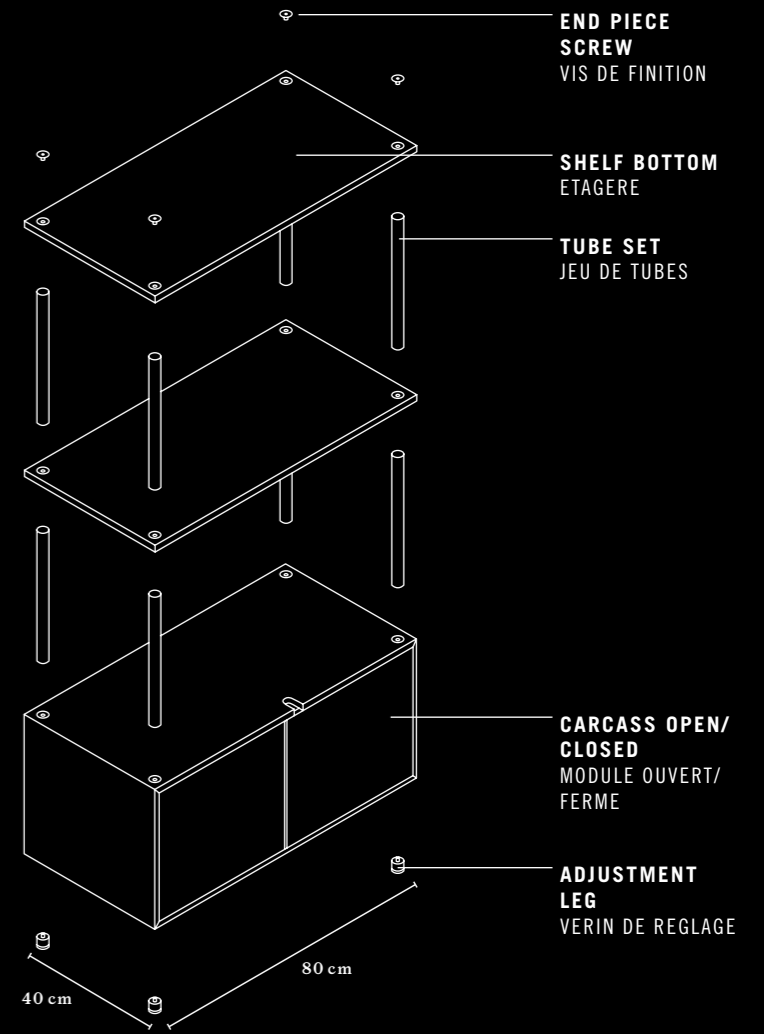
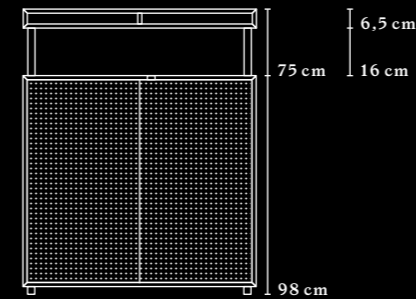

Max. height for free-standing shelves: 181cm
Max. height for wall-mounted sideboard: 181cm
Max. height for non-wall-mounted sideboard: 146cm
Hauteur max. pour des étagères en séparation d'espace : 181 cm
Hauteur max. pour un Sideboard mural : 181 cm
Hauteur max. pour un Sideboard en séparation d'espace : 146 cm

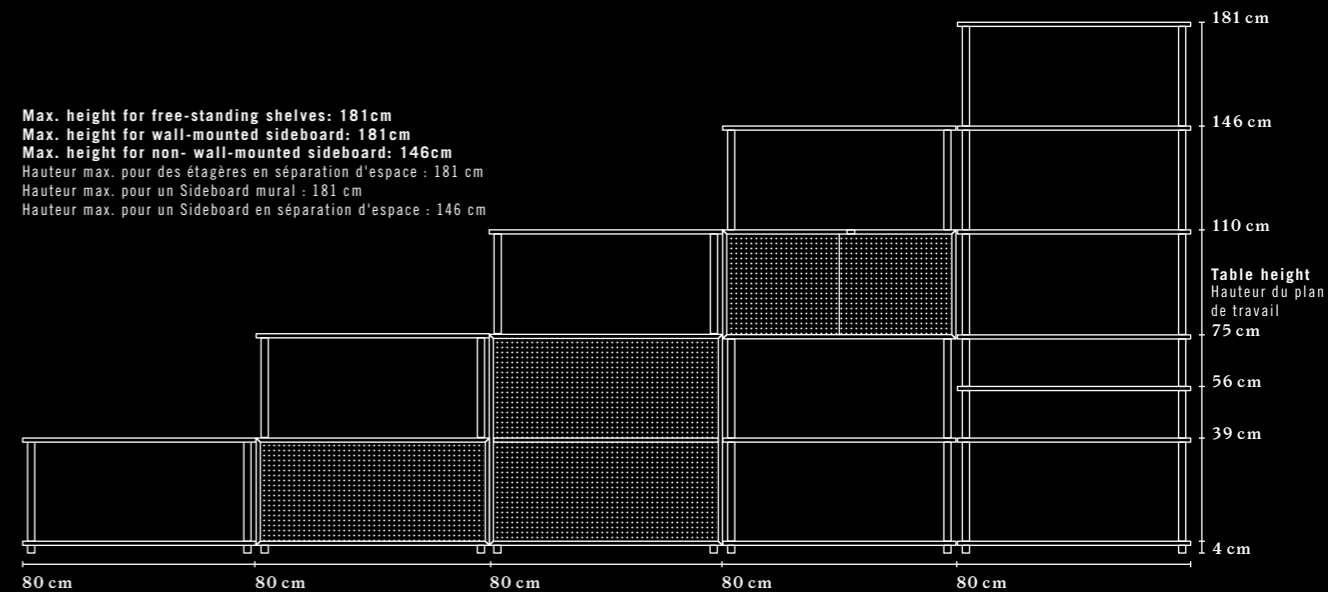

STUDIO ACCESSORIES

SHELF BOTTOM
ETAGERE

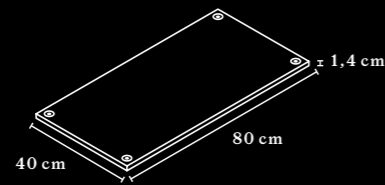

SHELF BOTTOM WITH BACKREST
ETAGERE AVEC FOND

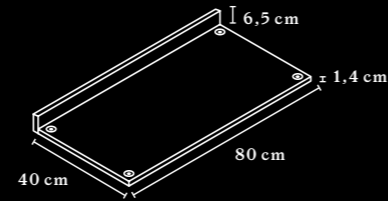

SHELVING UNIT
SURFACE DE DEPOSE

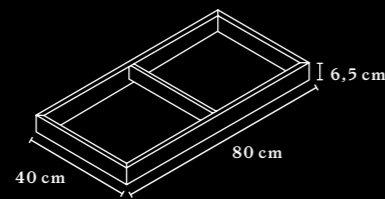

SHELVING UNIT SHELF
DOUBLE PLATEAU

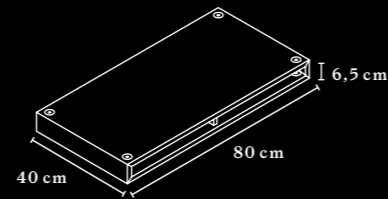

CARCASS OPEN
MODULE OUVERT

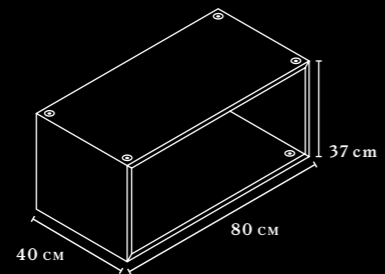

CARCASS CLOSED
MODULE FERME

Locking option available, without recess.
Verrouillage en option, sans découpe.

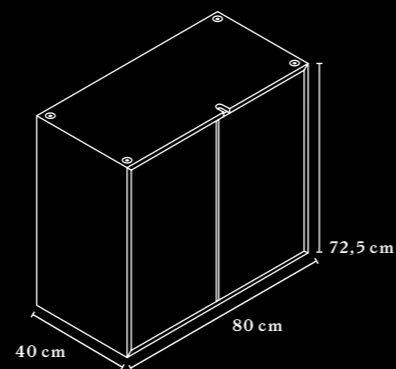
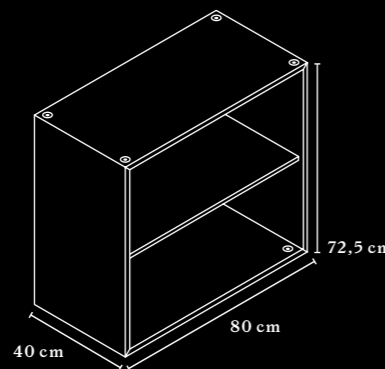
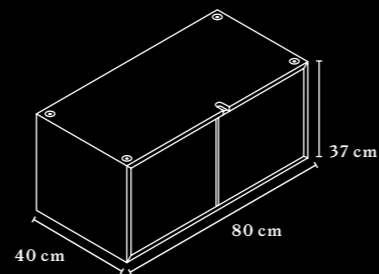

OVERVIEW & DIMENSIONS APERÇU & DIMENSIONS

MAGNETIC BOARD
PANNEAU MAGNETIQUE

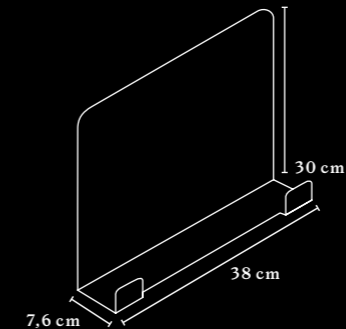

PANEL
ECRAN DE SEPARATION

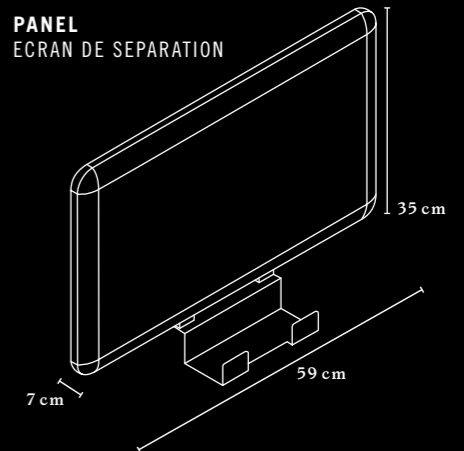

BOOKEND STORAGE
SERRE-LIVRES POUR RANGEMENT

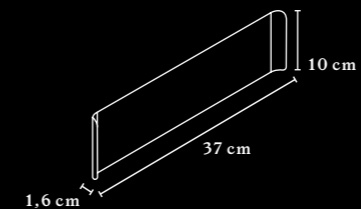

TRAY*
TIROIR*

* Only available in FENIX NTM®
* Disponible uniquement en FENIX NTM®

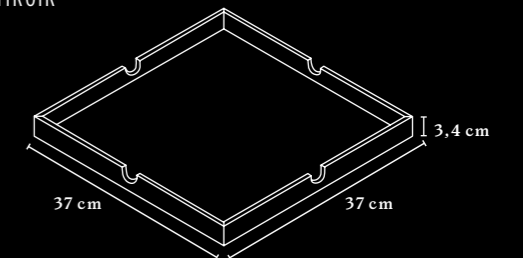

PLUGBOX
BOITIER CONNECTIQUE

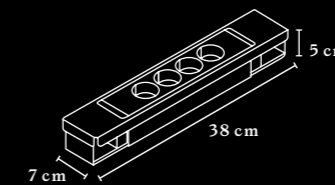

Plug board options:
4-way power socket
3-way power socket,
2x RJ45-CAT6
2-way power socket,
2x RJ45-CAT6,
1x VGA and audio
2-way power socket,
2x RJ45-CAT6,
1x HDMI and audio

Sélection de boîtiers connectiques :
Multiprise à 4 entrées
Multiprise à 3 entrées,
2x RJ45-CAT6
Multiprise à 2 entrées,
2x RJ45-CAT6,
1x VGA et audio
Multiprise à 2 entrées,
2x RJ45-CAT6,
1x HDMI et audio

COVER
CACHE

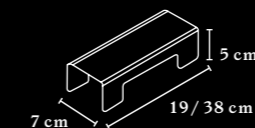

PENCIL TRAY
PLUMIER

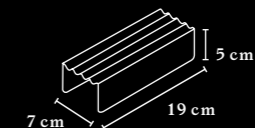
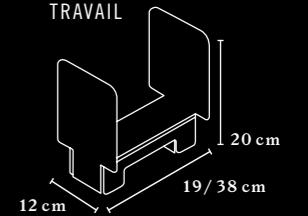

TABLE BOOKEND
SERRE-LIVRES POUR PLAN DE TRAVAIL



COLOURS & MATERIALS

COULEURS ET MATERIAUX

ACCESSORIES

ACCESSOIRES

POWDER COATING
RETEMENT THERMOLAQUE



SZ BLACK
NOIR



CU COPPER*
CUIVRE*

CERAMIC*
CERAMIQUE*



WI WHITE
BLANC

VENEER*
EBENISTERIE*

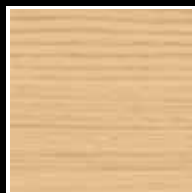

EY OAK SYLT
CHENE SYLT

* Only available for Toolbox
* Uniquement disponible pour la boîte à fournitures de bureau

TOOLBOX

BOITE POUR FOURNITURES DE BUREAU

POWDER COATING
RETEMENT THERMOLAQUE

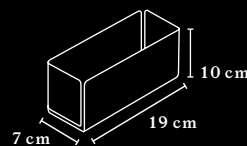
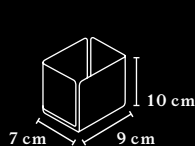

CERAMIC
CERAMIQUE



VENEER
EBENISTERIE

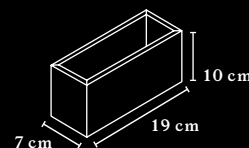
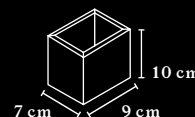

STUDIO PANEL

ECRAN DE SEPARATION STUDIO



Upholstered STUDIO panel: see Bene's fabric cover spectrum P0-P4.

Cloison avec revêtement tissu : voir le catalogue tissus Bene P0-P4.

PUBLISHER'S INFORMATION

MENTIONS LEGALES

Bene GmbH
Schwarzwiesenstrasse 3
3340 Waidhofen / Ybbs
Austria