

PARCS TABLES & STOOLS

OXYGEN FOR THE OFFICE

Whether cylindrical, on runners or with a star base – with designs that are both varied and characteristic, the PARCS side tables fit stylishly into the PARCS portfolio. They are also a functional supplement to the PARCS elements, as a standing table in the Toguna, or to the various seating elements. PARCS Tables are part of a multifunctional working environ-

ment where communication and recreation play a role. Small, comfortable and very mobile. The Pop-Up Stool can be easily moved wherever someone wants to take a seat. Thanks to the many different colour variations of the covers, the Pop-Up Stools can be used to set refreshing and bright accents. The stool is an optimal complement for all PARCS Settings.

Design: PearsonLloyd



bene

INSPIRING OFFICES. SINCE 1790.

PRODUCT DESCRIPTION

Pop-Up Stool: Sit anywhere you want. Fitted with glides. The standard version comes with plastic glides, optionally with felt glide pads. The bottom part is made of varnished shaped wood. Seat consists of a wooden substructure with dimensionally stable polyurethane foam padding. Optionally in flame-resistant version according to BS 5852 Part 2, Ignition Source 5 (Crib 5). Covers always come with double stitching.

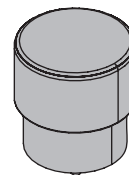

Pop-Up Table: Substructure made of varnished shaped wood, encased indeep-drawn plastic in white or black. With plastic legs.

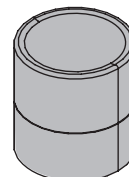

Cylinder Table: Substructures made of varnished shaped wood tubing. Table top made of varnished glass or MDF.

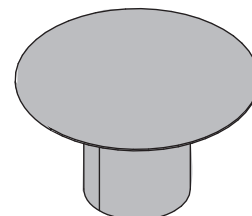

Ply Table: Table top made of shaped wood, veneered or varnished on chrome-plated steel tube frame.

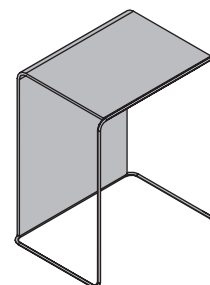

Tables for Toguna - Toguna Table low and Toguna Table high: plastic cylindrical column on base, table top MDF 25mm. Varnished plastic in WI white or SZ black, table top available varnished, base in SZ black, powder-coated.

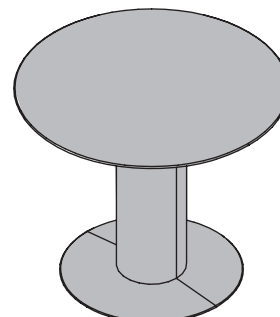

OVERVIEW & DIMENSIONS

POP-UP STOOL

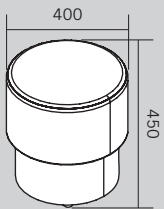

POP-UP TABLE

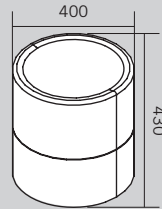

CYLINDER TABLE

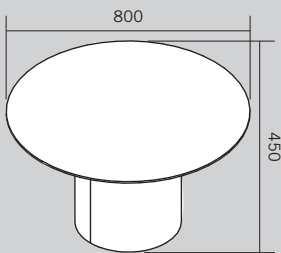

PLY TABLE

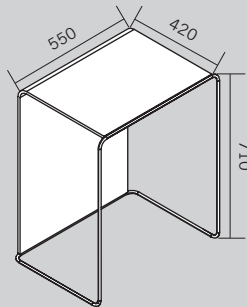

TOGUNA TABLE LOW

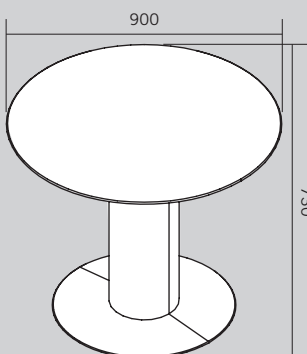

TOGUNA TABLE HIGH

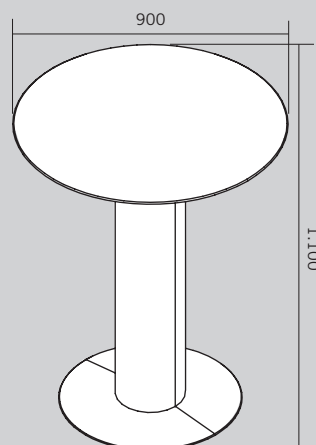

Measurements in mm

INSPIRATIONS



Ply Table with Pop-Up Stool.



Cylinder Table with Club Chair.

COLOURS & MATERIALS



Various fabric and leather collections are available for the cover: Urban Plus, Xtreme Plus, Step, Step Melange, Patina, Remix, Europost, Clara, Mainline Flax, Divina, Steelcut, Stamskin Top, Fiord, Hallingdal, Steelcut Trio, Divina Melange, Divina MD, Greenwich, Greenwich Uni, Entrée, Entrée Color and Superior.
More information about the specific fabric and leather collections is available at www.bene.com.

POP-UP STOOL

MDF SURFACES: Varnished

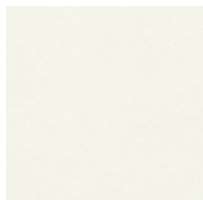

WI white

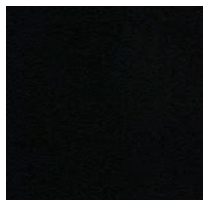

BS basalt

POP-UP TABLE & TOGUNA TABLE LOW/HIGH

MDF SURFACES: Varnished

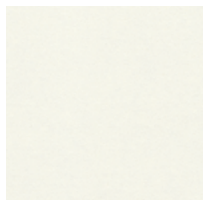

WI white

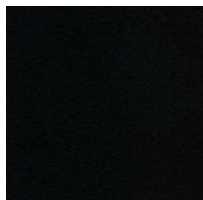

BS basalt

PLASTIC SURFACE

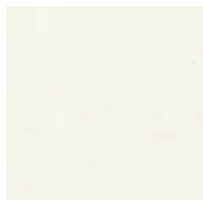

WI white

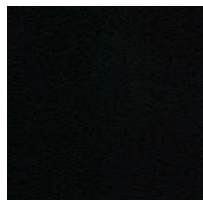

BS basalt

COLOURS & MATERIALS

CYLINDER TABLE

MDF SURFACES: Varnished

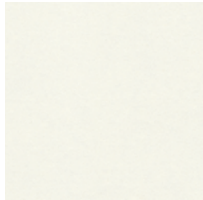

WI white

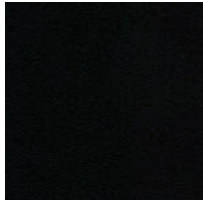

BS basalt

GLASS: Varnished

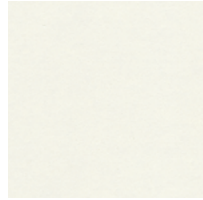

DW opaque white



DS opaque black

PLY TABLE

MDF SURFACES: Varnished

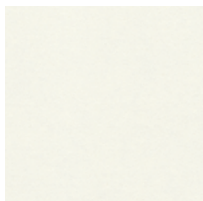

WI white

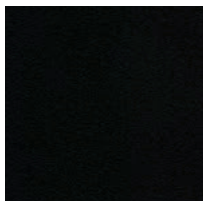

BS basalt

VENEER: Oak

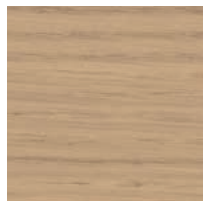

EY oak, sylvia

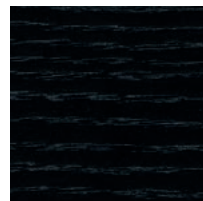

EV oak, volcano

METAL SURFACE: Galvanised



CR chrome

BENE WORKS SUSTAINABLY

Bene plays a leading role in responsible environmental management. This policy is practised throughout all company divisions – from product development, procurement, production and logistics to product recycling. Bene considers ecology to be a central element of its responsible and sustainable corporate strategy. Bene sees the legal regulations as minimum requirements and strives for better and more sustainable environmental protection throughout the group. Bene's environmental policy principle is: **Avoidance – Minimisation – Recycling – Disposal.**

POP-UP STOOL – ECOLOGICAL STANDARDS

- 99% recyclable
- 95.50% renewable raw materials
- 10.23% use of recycled product materials (0.47% post-consumer, 9.76% pre-consumer)
- 5.35% use of recycled product materials that comply with LEED (0.47% post-consumer, 9.76% pre-consumer)
- Resource-conserving product design
- Use of materials tested for presence of hazardous substances
- No PVCs, chromium, lead or mercury
- Individual parts can be sorted according to homogeneous categories
- Recyclable, with a positive contribution to the carbon footprint(average 11.90 kg CO₂)

POP-UP STOOL LEED POINTS

Leadership in Energy and Environmental Design (LEED) is a system developed by the U.S. Green Building Council to classify ecological construction. As an internationally recognised standard, LEED sets out numerous guidelines for environmentally friendly, resource-efficient, and sustainable construction. The use of Pop-up Stool is an important contribution to LEED certification. The following criteria for this are from »LEED 2009 for Commercial Interiors«:

| | | |
|----------------|---|----------------|
| MR Credit 4 | Recycled content | up to 2 points |
| MR Credit 5 | Regional materials | up to 2 points |
| IEQ Credit 4.5 | Material with low hazardous substance content | up to 1 point |

POP-UP STOOL MATERIAL COMPONENTS

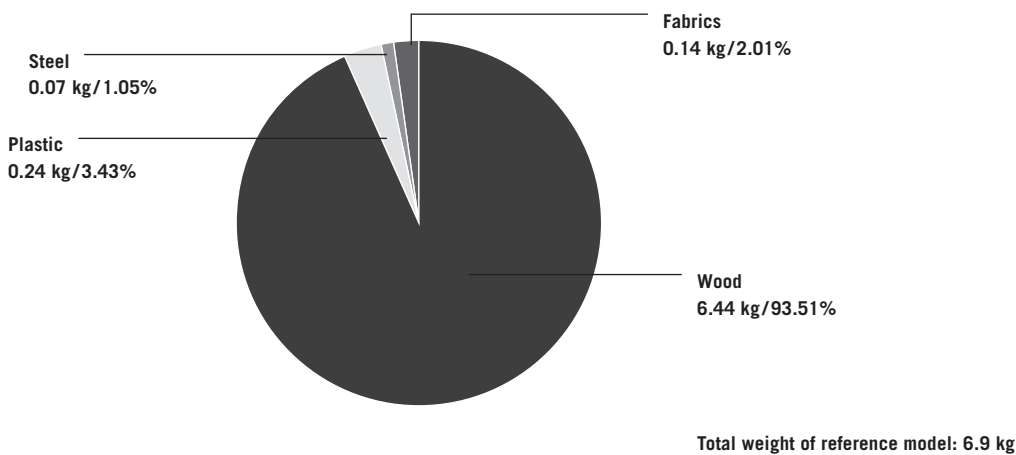

Environment-related information about Bene: www.bene.com/sustainability



The mark of responsible forestry
(on request)