

# PARCS TABLES & STOOLS

Whether cylindrical, on runners or with a star base – with designs that are both varied and characteristic, the PARCS side tables fit stylishly into the PARCS portfolio. They are also a functional supplement to the PARCS elements, as a standing table in the Toguna, or to the various seating elements. PARCS Tables are part of a multifunctional working environment where

communication and recreation play a role. Small, comfortable and very mobile. The Pop-Up Stool can be easily moved wherever someone wants to take a seat. Thanks to the many different colour variations of the covers, the Pop-Up Stools can be used to set refreshing and bright accents. The stool is an optimal complement for all PARCS Settings.

**Design: PearsonLloyd**



## PRODUCT DESCRIPTION

**Pop-Up Stool:** Sit anywhere you want. Fitted with glides. The standard version comes with plastic glides, optionally with felt glide pads. The bottom part is made of varnished shaped wood. Seat consists of a wooden substructure with dimensionally stable polyurethane foam padding. Optionally in flame-resistant version according to BS 5852 Part 2, Ignition Source 5 (Crib 5). Covers always come with double stitching.

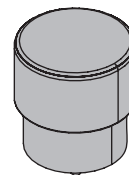

**Pop-Up Table:** Substructure made of varnished shaped wood, encased indeep-drawn plastic in white or black. With plastic legs.

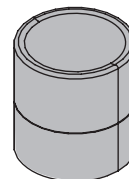

**Cylinder Table:** Substructures made of varnished shaped wood tubing. Table top made of varnished glass or MDF.

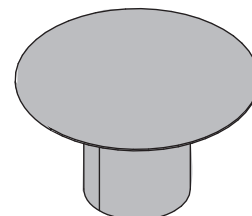

**Ply Table:** Table top made of shaped wood, veneered or varnished on chrome-plated steel tube frame.

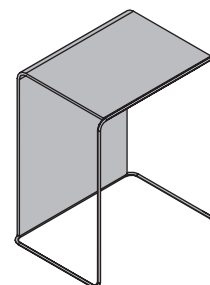

**Tables for Toguna - Toguna Table low and Toguna Table high:** plastic cylindrical column on base, table top MDF 25mm. Varnished plastic in WI white or SZ black, table top available varnished, base in SZ black, powder-coated.

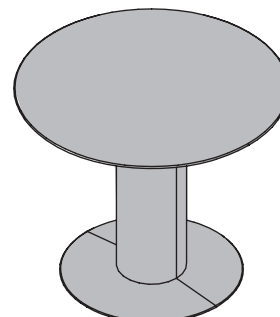

## OVERVIEW & DIMENSIONS

**POP-UP STOOL**

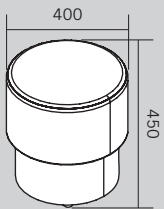

**POP-UP TABLE**

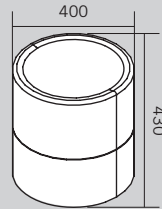

**CYLINDER TABLE**

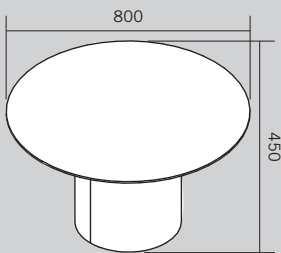

**PLY TABLE**

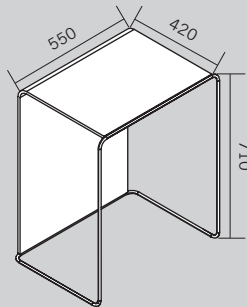

**TOGUNA TABLE LOW**

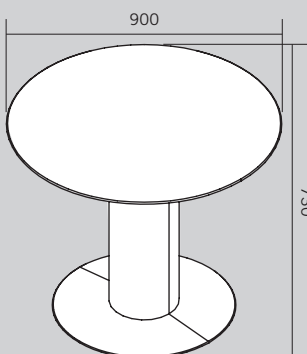

**TOGUNA TABLE HIGH**

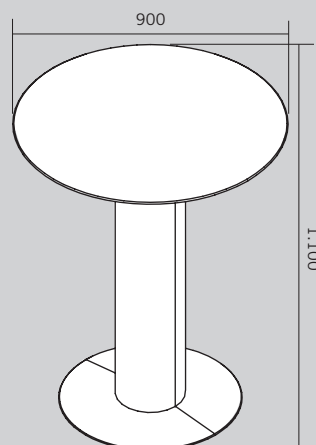

Measurements in mm

## INSPIRATIONS



Ply Table with Pop-Up Stool.

---



Cylinder Table with Club Chair.

## COLOURS & MATERIALS



Various fabric and leather collections are available for the cover: Urban Plus, Xtreme Plus, Step, Step Melange, Patina, Remix, Europost, Clara, Mainline Flax, Divina, Steelcut, Stamskin Top, Fiord, Hallingdal, Steelcut Trio, Divina Melange, Divina MD, Greenwich, Greenwich Uni, Entrée, Entrée Color and Superior.  
More information about the specific fabric and leather collections is available at [www.bene.com](http://www.bene.com).

---

### POP-UP STOOL

#### MDF SURFACES: Varnished

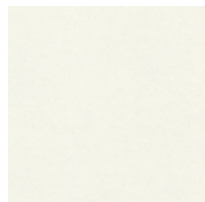

WI white

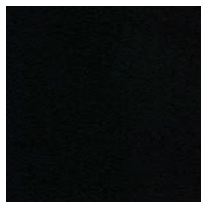

BS basalt

---

### POP-UP TABLE & TOGUNA TABLE LOW/HIGH

#### MDF SURFACES: Varnished

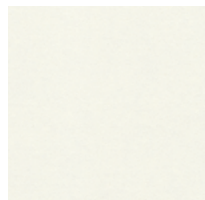

WI white

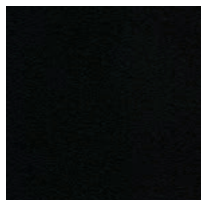

BS basalt

#### PLASTIC SURFACE



WI white

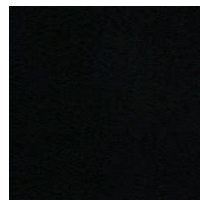

BS basalt

## COLOURS & MATERIALS

### CYLINDER TABLE

#### MDF SURFACES: Varnished

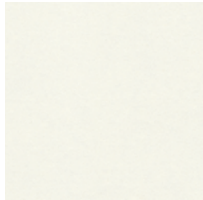

WI white



BS basalt

#### GLASS: Varnished

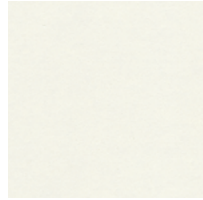

DW opaque white



DS opaque black

---

### PLY TABLE

#### MDF SURFACES: Varnished

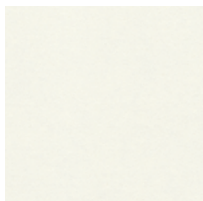

WI white

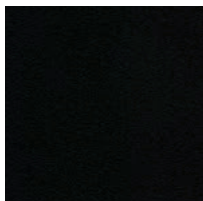

BS basalt

#### VENEER: Oak

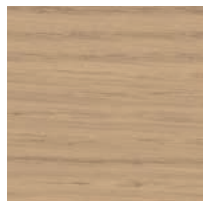

EY oak, sylt

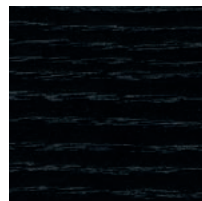

EV oak, volcano

#### METAL SURFACE: Galvanised

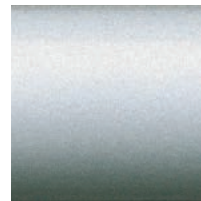

CR chrome

## BENE WORKS SUSTAINABLY

Bene plays a leading role in responsible environmental management. This policy is practised throughout all company divisions – from product development, procurement, production and logistics to product recycling. Bene considers ecology to be a central element of its responsible and sustainable corporate strategy. Bene sees the legal regulations as minimum requirements and strives for better and more sustainable environmental protection throughout the group. Bene's environmental policy principle is: **Avoidance – Minimisation – Recycling – Disposal.**

### POP-UP STOOL – ECOLOGICAL STANDARDS

- 99% recyclable
- 95.50% renewable raw materials
- 10.23% use of recycled product materials (0.47% post-consumer, 9.76% pre-consumer)
- 5.35% use of recycled product materials that comply with LEED (0.47% post-consumer, 9.76% pre-consumer)
- Resource-conserving product design
- Use of materials tested for presence of hazardous substances
- No PVCs, chromium, lead or mercury
- Individual parts can be sorted according to homogeneous categories
- Recyclable, with a positive contribution to the carbon footprint(average 11.90 kg CO<sub>2</sub>)

## POP-UP STOOL LEED POINTS

Leadership in Energy and Environmental Design (LEED) is a system developed by the U.S. Green Building Council to classify ecological construction. As an internationally recognised standard, LEED sets out numerous guidelines for environmentally friendly, resource-efficient, and sustainable construction. The use of Pop-up Stool is an important contribution to LEED certification. The following criteria for this are from »LEED 2009 for Commercial Interiors«:

MR Credit 4	Recycled content	up to 2 points
MR Credit 5	Regional materials	up to 2 points
IEQ Credit 4.5	Material with low hazardous substance content	up to 1 point

### POP-UP STOOL MATERIAL COMPONENTS

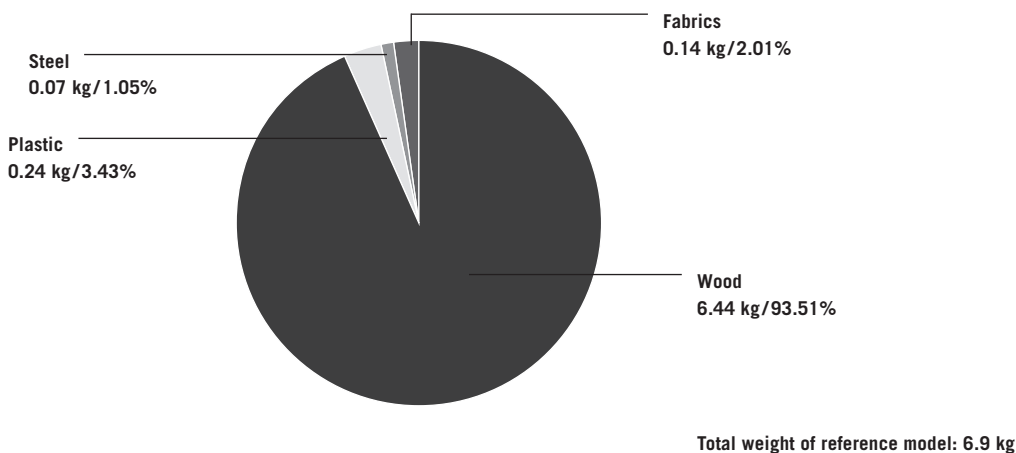

Environment-related information about Bene: [www.bene.com/sustainability](http://www.bene.com/sustainability)



The mark of responsible forestry  
(on request)