

MEDIA BOARD

Elegant and slim media furniture for digital collaboration in a team. Versatile and easy to use, the Media Boards can be integrated into the Toguna Circle and the Toguna Square – or be mounted directly on to a wall. All without using up too much space. The body is made of metal, white powder-coated with an attachment to hold the monitor. It offers storage

space for utensils, a Micro PC and a connection plug board for the monitor port. To make it more convenient to operate from the outside, you can also order optional cable management on the side consisting of a freely accessible connection plug board, a removable cable winder for extra long cables, and a place to store the remote control for the monitor.

Design: PearsonLloyd



*Model in custom height with video conferencing equipment available upon request.

PRODUCT DESCRIPTION

- ❶ **Carcass element:** Bottom element has a hinged door and contains a shelf. Circumference of the carcass covered with 3 mm steel sheets, powder-coated in white (WI). Covers on side and interior in chipboard basalt melamine (MB).
- ❷ **Attachment element:** Two boards for attaching a screen holder. Front chipboard has a cable outlet. Rear board is removable for easier cable access, Chipboard in basalt melamine (MB) and cable outlet in black (SZ).
- ❸ **Screen:** max. 30 kg, max. height: 720 mm / width: 1.250 mm, optimised for NEC V484
- ❹ **Screen holder:** prepared for screen holder SMS Func Flatscreen WM T. (must be ordered separately)
- ❺ **Spacing strip:** only for Toguna Circle
- ❻ **3-fold connection plug board:** (part of the cabling package)

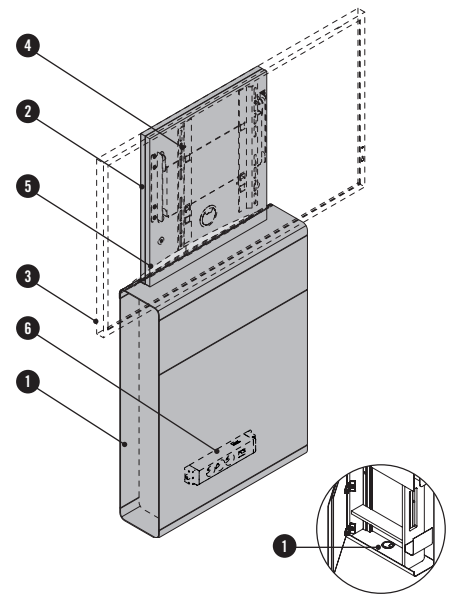

The media board can be installed in Toguna Square and Toguna Circle or can be mounted to a wall. It is attached to the Toguna with screws. Not suitable for standalone use.

OVERVIEW & DIMENSIONS

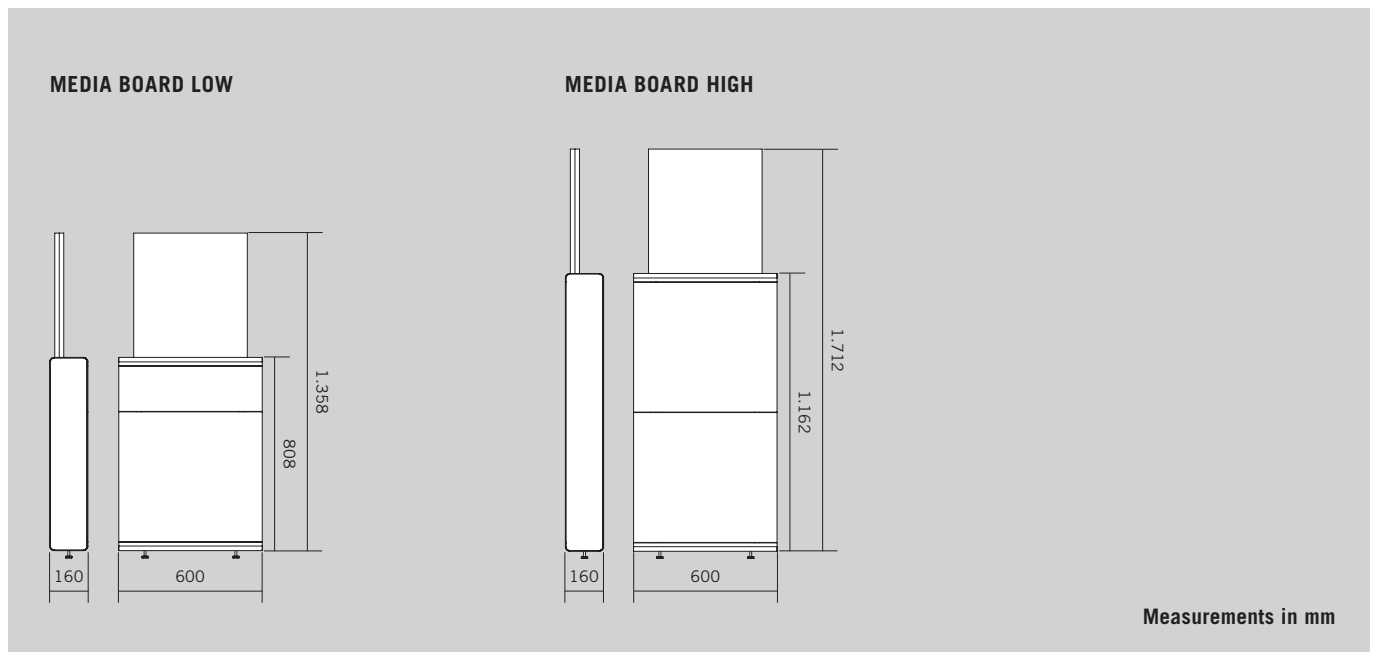

OPTIONS

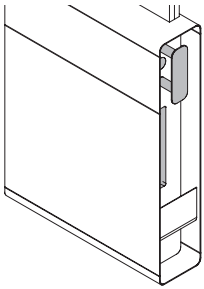

Integrated cable management

An integrated cable management can be selected on the right side of the media board. It contains preparations for a connection plug board, a removable cable winding feature and openings on the outside to thread cables through.

MEDIA BOARD CABLING

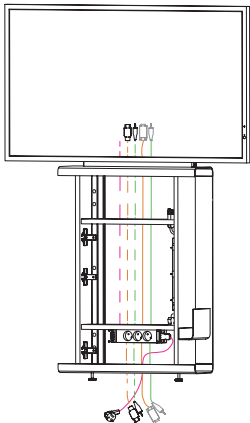

Media Board without cable management on the side

VGA Package:

- Connection plug board with 3 power sockets
- 1x electrical starter cable GST18 5.000 mm
- 1x Interconnecting VGA -/ Audio cable 5.000 mm

HDMI Package

- Connection plug board with 3 power sockets
- 1x electrical starter cable GST18 5.000 mm
- 1x Interconnecting HDMI cable 5.000 mm
- 1x Interconnecting audio cable 5.000 mm

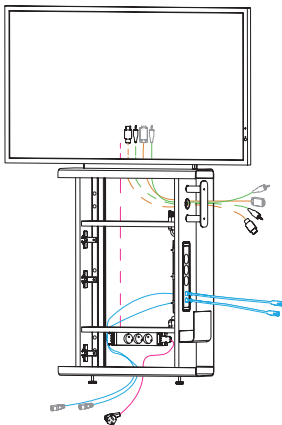

Media Board with cable management on the side

(connection plug board on the side, with power and data connection)

VGA Package:

- Connection plug board with 3x power sockets, 2x power sockets and 2x data connections
- 1x electrical starter cable GST18 5.000 mm
- 1x electrical interconnecting cable GST18 2.000 mm
- 2x interconnecting network cable for CAT6 5.000 mm
- 1x Interconnecting VGA -/ audio cable 3.000 mm

HDMI Package

- Connection plug board with 3x power sockets, 2x power sockets and 2x data connections
- 1x electrical starter cable GST18 5.000 mm
- 1x electrical interconnecting cable GST18 2.000 mm
- 2x interconnecting network cable for CAT6 5.000 mm
- 1x HDMI interconnecting cable 3.000 and audio interconnecting cable 3.000 mm

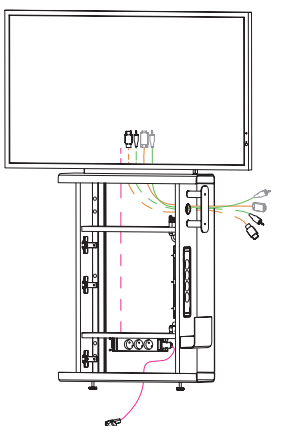

Media Board with cable management on the side

(connection plug board on the side, with power connection)

VGA Package:

- Connection plug board with 3x power sockets, 4x power sockets
- 1x electrical starter cable GST18 5.000 mm
- 1x electrical interconnecting cable GST18 2.000 mm
- 1x Interconnecting VGA -/ audio cable 3.000 mm

HDMI Package

- Connection plug board with 3x power sockets, 4x power sockets
- 1x electrical starter cable GST18 5.000 mm
- 1x electrical interconnecting cable GST18 2.000 mm
- 1x HDMI interconnecting cable 3.000 and audio interconnecting cable 3.000 mm

INSPIRATIONS



Toguna Circle with TIMBA Table and Media Board low
incl. cable management on the side.



Bay Chair with TIMBA Table and Media Board VC low
incl. cable management on the side (upon request).

INSPIRATIONS

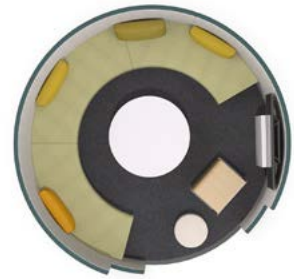

Toguna Circle with Club Table and Media Board low
incl. cable management on the side.



Toguna Square with Club Table and Media Board high
incl. cable management on the side.

BENE WORKS SUSTAINABLY

Bene plays a leading role in responsible environmental management. This policy is practised throughout all company divisions – from product development, procurement, production and logistics to product recycling. Bene considers ecology to be a central element of its responsible and sustainable corporate strategy. Bene sees the legal regulations as minimum requirements and strives for better and more sustainable environmental protection throughout the group. Bene's environmental policy principle is: **Avoidance – Minimisation – Recycling – Disposal.**

MEDIA BOARD - ECOLOGICAL STANDARDS

- 99.5% recyclable
- 46.2% renewable raw materials
- 59.46% use of recycled product materials (37.55% post-consumer, 21.90% pre-consumer)
- 46.07% use of recycled product materials that comply with LEED (37.55% post-consumer, 21.90% pre-consumer)
- Resource-conserving product design
- Use of materials tested for presence of hazardous substances
- No PVCs, chromium, lead or mercury
- Individual parts can be sorted according to homogeneous categories
- Recyclable, with a positive contribution to the carbon footprint(average 61 kg CO₂)

MEDIA BOARD LEED POINTS

Leadership in Energy and Environmental Design (LEED) is a system developed by the U.S. Green Building Council to classify ecological construction. As an internationally recognised standard, LEED sets out numerous guidelines for environmentally friendly, resource-efficient, and sustainable construction. The use of Media Board is an important contribution to LEED certification. The following criteria for this are from »LEED 2009 for Commercial Interiors«:

MR Credit 4	Recycled content	up to 2 points
MR Credit 5	Regional materials	up to 2 points
IEQ Credit 4.5	Material with low hazardous substance content	up to 1 point

MEDIA BOARD MATERIAL COMPONENTS

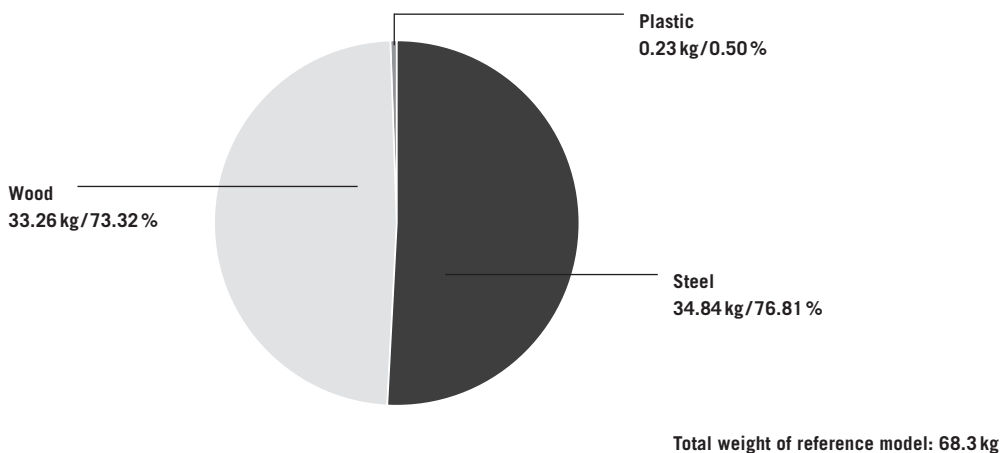

Environment-related information about Bene: www.bene.com/sustainability