

CUBE_S

SETTINGS

BRIDGE

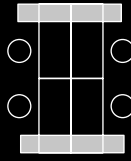
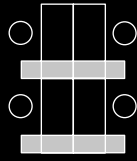

SPINE

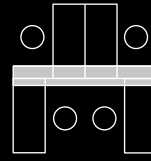

CROSS

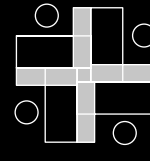

CLUSTER

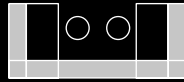
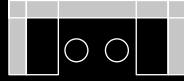
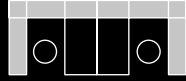

ABSCHIRMUNG SCREENING ELEMENTS

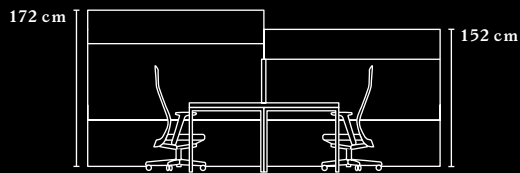
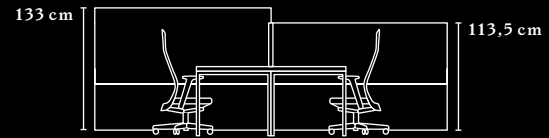
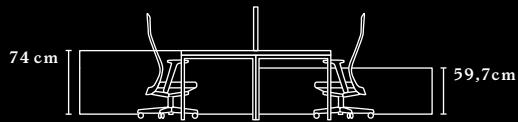

CUBE_S MODULSCHRANK CUBE_S MODULE CABINET

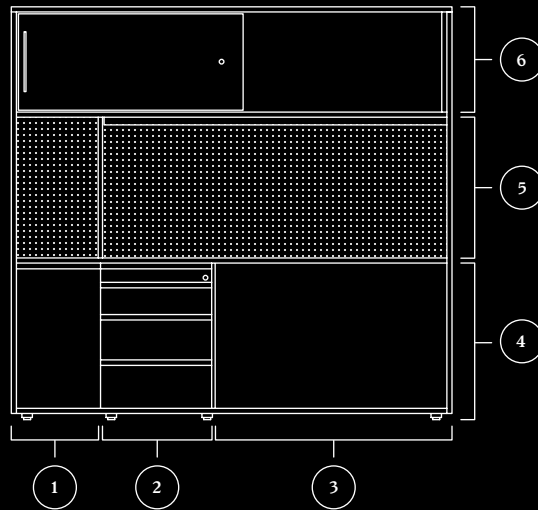

- 1 Zusatzmodul
Additional module
- 2 Ladenmodul
Drawer module
- 3 Tischanbaumodul
Desk connection module
- 4 Modulschrank
Module cabinet
- 5 Box
Box
- 6 Box mit Schiebetür
Box with sliding door

MODULSCHRANK EINSEITIG (BRIDGE, CROSS, CLUSTER) MODULE CABINET ONE-SIDED (BRIDGE, CROSS, CLUSTER)

2 Module
2 Modules

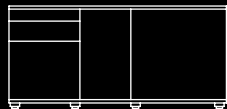

Tischtiefe / Schrankbreite
Table depth / Cabinet width

80 cm / 130 cm
90 cm / 140 cm

3 Module
3 Modules

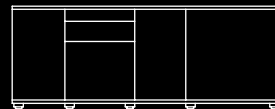

Tischtiefe / Schrankbreite
Table depth / Cabinet width

80 cm / 150 – 190 cm
90 cm / 160 – 200 cm

MODULSCHRANK WECHSEL- SEITIG (SPINE) MODULE CABINET TWO-SIDED (SPINE)

3 Module
3 Modules

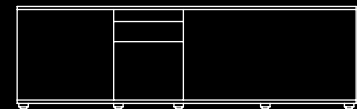

Tischtiefe / Schrankbreite
Table depth / Cabinet width

80 cm / 180 – 220 cm
90 cm / 190 – 220 cm

CUBE_S SCHIEBETÜRSCHRANK / SLIDING DOOR CABINET

DIMENSIONEN DIMENSIONS

¹ OH = Ordnerhöhe
¹ OH = File height

SCHIEBETÜRSCHRANK SLIDING DOOR CABINET

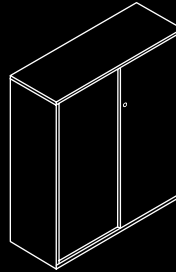
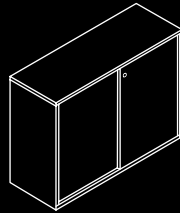
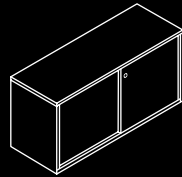

Höhe | Height
1,5 – 4 OH¹
59,7 / 72 / 74 / 94 /
113,5 / 133 / 152 cm
Breite | Width
80 – 160 cm
Tiefe | Depth
30 – 60 cm

SCHIEBETÜRSCHRANK MIT BOX SLIDING DOOR CABINET WITH BOX

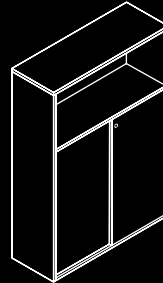
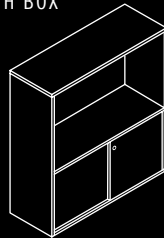
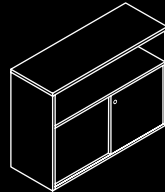

Höhe | Height
1,5 – 4 OH¹
94 / 113,5 / 133 / 152 /
172 / 191 cm
Breite | Width
80 – 160 cm
Tiefe | Depth
30 – 60 cm

BOX VARIANTEN BOX OPTIONS

Der Zugriff kann wahlweise von der Vorderseite des Schiebetürschranks oder von dessen Rückseite erfolgen.

Access can be from the front or rear side of the sliding door cabinet.

OFFEN OPEN

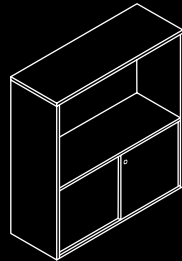

MIT FACHTEILER MITTIG WITH COMPARTMENT DIVIDERS IN THE CENTRE

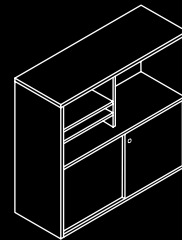
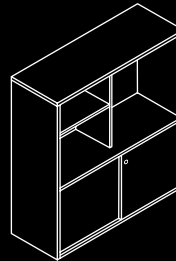
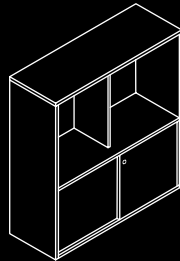

1 oder 2 Fachböden links oder rechts positioniert
One or two shelves positioned on the left or right

TISCHANBINDUNG CONNECTION MODULE

ANBINDUNG VON TISCHEN IN FIXER HÖHE CONNECTION OF TABLES AT A FIXED HEIGHT

AN SCHIEBETÜRSCHRANK ON THE SLIDING DOOR CABINET

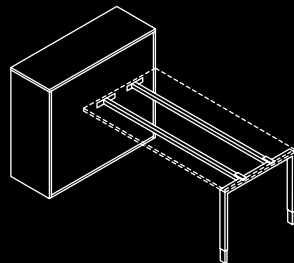

MIT BOX WITH BOX

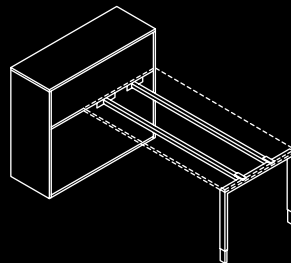

IN TISCHHÖHE AUF 72 / 74 / 76 CM AT THE TABLE HEIGHTS OF 72 / 74 / 76 CM

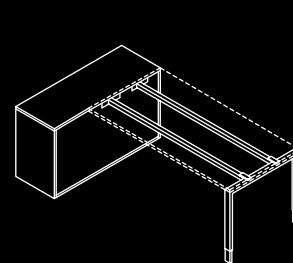

ANBINDUNG VON HÖHENEINSTELLBAREN TISCHEN CONNECTION OF HEIGHT ADJUSTABLE TABLES

AN SCHIEBETÜRSCHRANK ON THE SLIDING DOOR CABINET

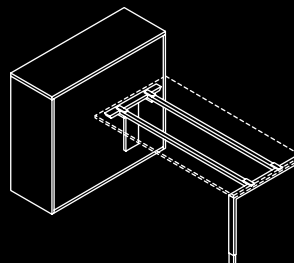

MIT BOX WITH BOX

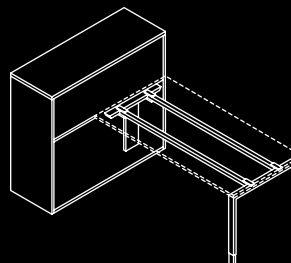

IN TISCHHÖHE AUF 72 / 74 / 76 CM AT THE TABLE HEIGHTS OF 72 / 74 / 76 CM

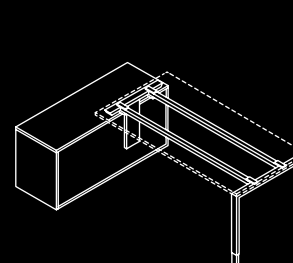

Weitere Details und Informationen sind im Produktdatenblatt angeführt.
Additional details and information can be found in the product datasheet.

CUBE_S TOWER UNIT

PORTFOLIO

¹ OH = Ordnerhöhe
¹ OH = File height

TOWER UNIT 1,5 OH¹

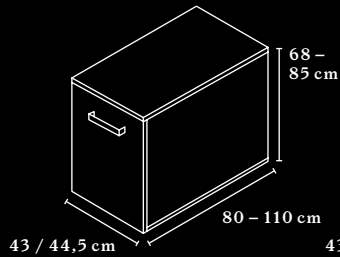

TOWER UNIT 2,5 OH¹

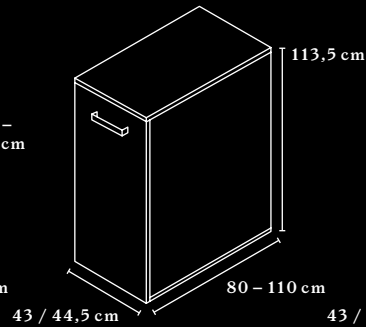

TOWER UNIT 3 OH¹

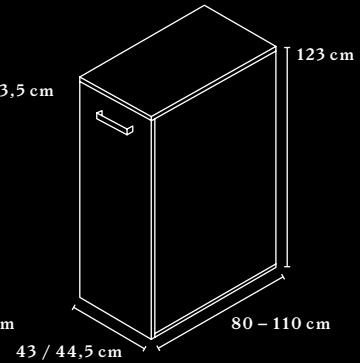

TOWER UNIT MIT
CUBE_S BOX
 TOWER UNIT WITH
 CUBE_S BOX

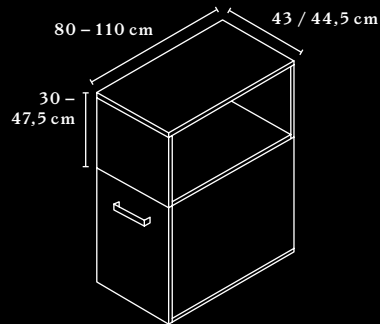

KABELFÜHRUNG
 CABLE ROUTING

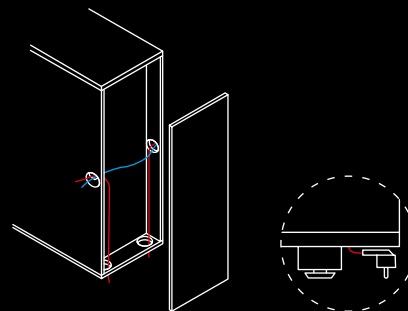

**AUSSEN- UND
 INNENKORPUS**
 EXTERNAL
 AND INTERNAL
 CARCASSES

AUSSENKORPUS
 EXTERNAL CARCASS

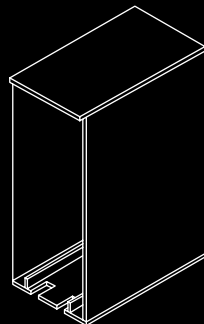

**INNENKORPUS MIT
 EINSEITIGEM ZUGRIFF**
 INTERNAL CARCASS WITH
 ONE-SIDED ACCESS

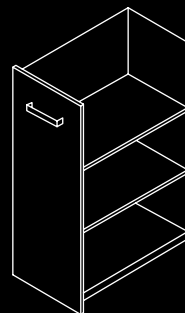

**INNENKORPUS MIT WECHSEL-
 SEITIGEM ZUGRIFF**
 INTERNAL CARCASS WITH ACCESS
 FROM BOTH SIDES

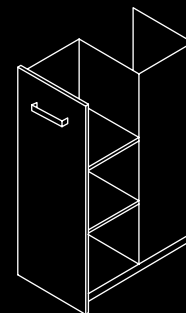

TISCHANBINDUNG
 CONNECTION
 MODULE

HÖHENEINSTELLBAR
 HEIGHT ADJUSTABLE

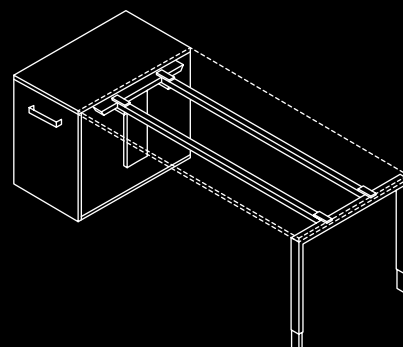

FIXE HÖHE
 FIXED HEIGHT

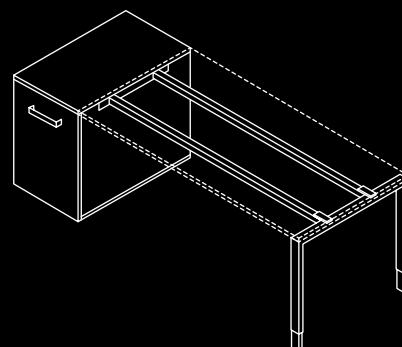

Weitere Details und Informationen sind im Produktdatenblatt angeführt.
 Additional details and information can be found in the product datasheet.

CUBE_S BOX

CUBE_S BOX PORTFOLIO

CUBE_S BOX AUF SCHRANK
CUBE_S BOX ON CABINET

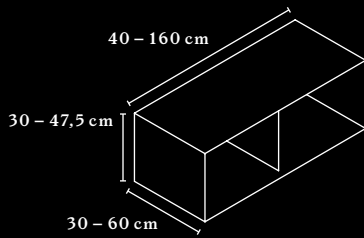

CUBE_S BOX AUF TISCH
CUBE_S BOX ON DESK

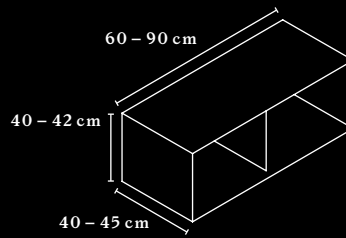

CUBE_S BOX AN WAND
CUBE_S BOX ON WALL

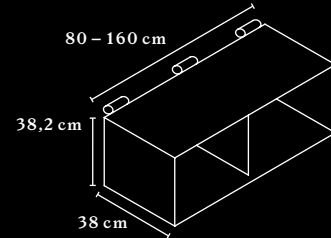

**CUBE_S BOX MIT
EINSCHUBKLAPPE**
CUBE_S BOX WITH
INSERT FLAP

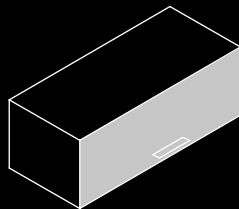

**Spanplatte mit Melamin- oder Furnier-
oberfläche, Griff in Weiß, Aluminium oder
Schwarz, optional mit Schloss.**
Chipboard with melamine or veneered
surface, handle white, aluminium, or black,
lock is optional.

**CUBE_S BOX MIT
SCHIEBETÜREN**
CUBE_S BOX WITH
SLIDING DOORS

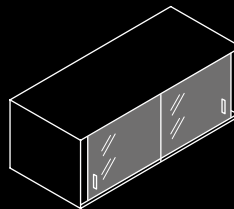

**Plexiglas 4 mm,
Griffleiste in Aluminium eloxiert.**
Perspex, 4 mm, with anodised
aluminium grip ledge.

Weitere Details und Informationen sind im Produktdatenblatt angeführt.
Additional details and information can be found in the product datasheet.