

SIDE_S

SIDE_S brings colour, wood, and comfort to the workplace and offers the functionality of personal accessory furniture provided in novel manner. An intelligent mix of mobile individual furniture elements inspires workstations that distinguish themselves

with a high level of comfort and enhanced options. Side by side, always within reach. The SIDE_S range consists of pedestal, caddy, sideboard, and credenza, inspires the viewer with its characteristic design. Comfortable functionality in the office.



bene

INSPIRING OFFICES. SINCE 1790.

PRODUCT DESCRIPTION

- ❶ **Top plate:** 25 mm chipboard, melamine
- ❷ **Visible side:** 12 mm plywood, veneered
- ❸ **Rear wall:** 16 mm chipboard, melamine
- ❹ **Handle:** available in aluminium WI white or SZ black
- ❺ **Low drawer:** 16 mm chipboard, melamine
- ❻ **Accessory tray:** 16 mm chipboard, melamine
- ❼ **Hinged door:** 16 mm chipboard, melamine
- ❽ **Bottom:** 25 mm chipboard, melamine
- ❾ **Castor:** soft or hard available (only with SIDE_S Pedestal/Sideboard)
- ❿ **Runner:** with glides, in chrome, adjustable
- ⓫ **Shelf**

Drawers and doors are dampened. Rear wall and front always have the same colour design.

SIDE_S Pedestal

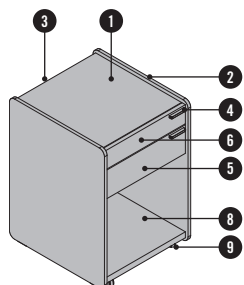

SIDE_S Caddy

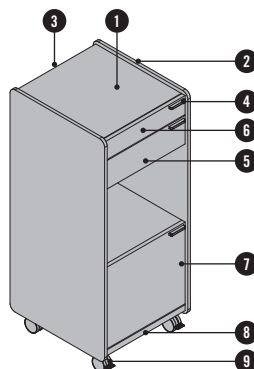

SIDE_S Sideboard

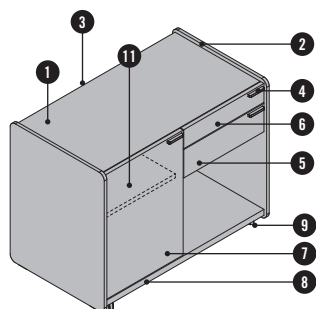

SIDE_S Credenza

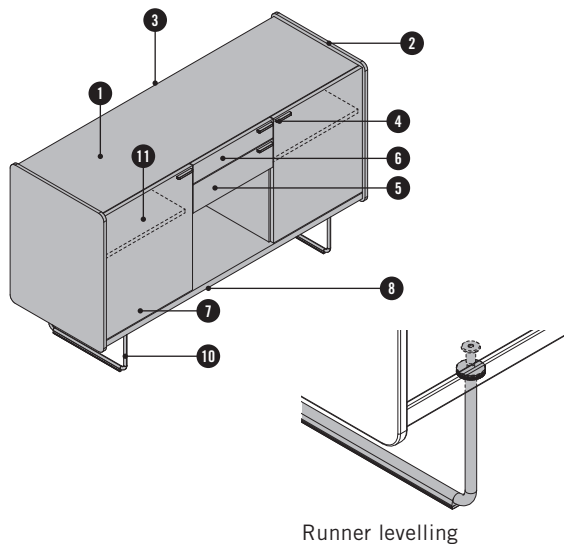

Runner levelling

OVERVIEW & DIMENSIONS

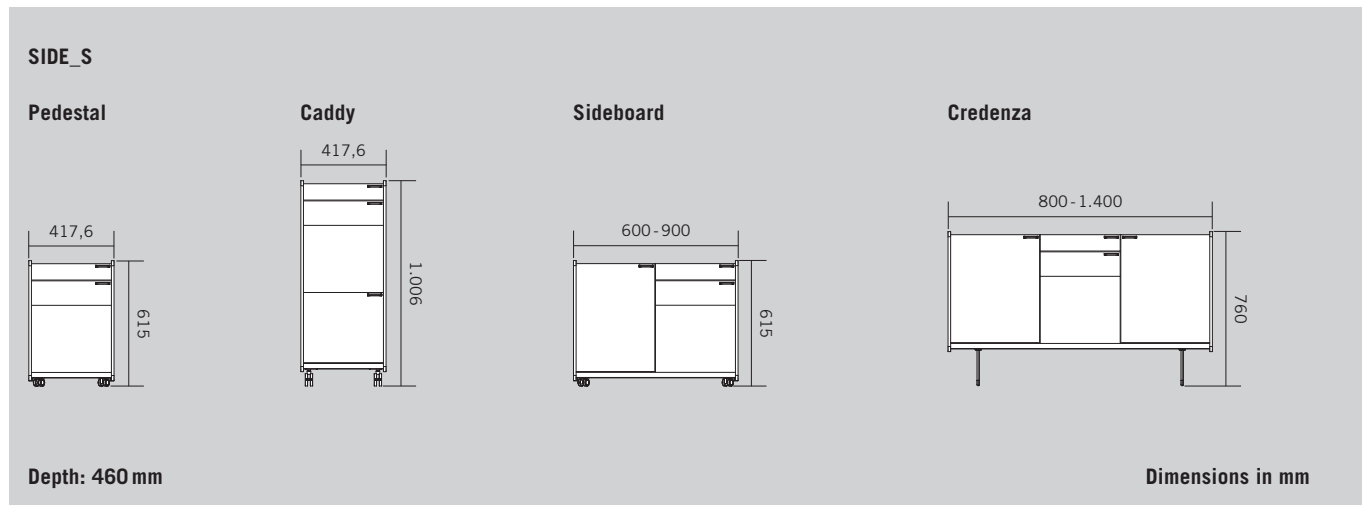

DRAWERS

Partial pull-out system

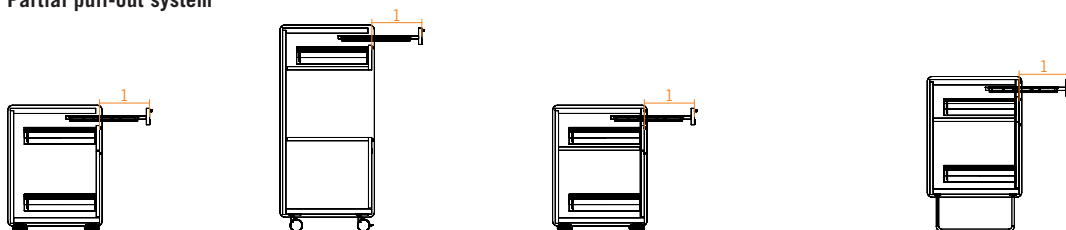

Full pull-out system

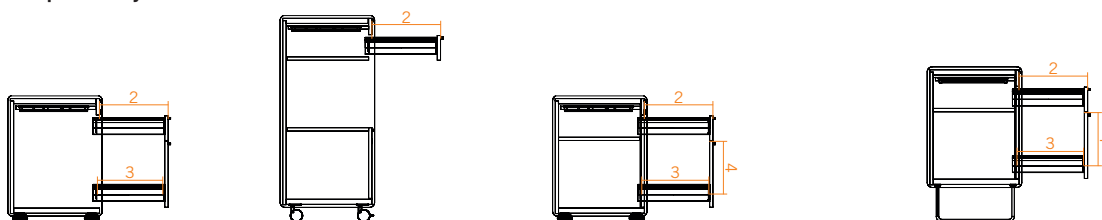

- 1 pull-out length: 244 mm
- 2 pull-out length: 334 mm
- 3 useful depth: 332 mm
- 4 useful height: 261 mm

OPTIONS

FRONT DESIGNS

Pedestal



Caddy¹

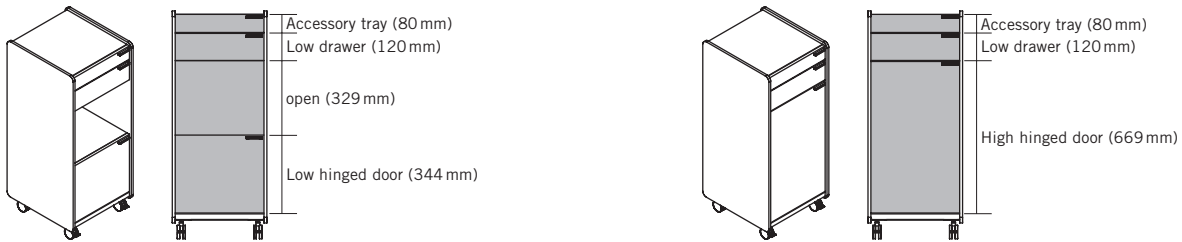

Sideboard¹

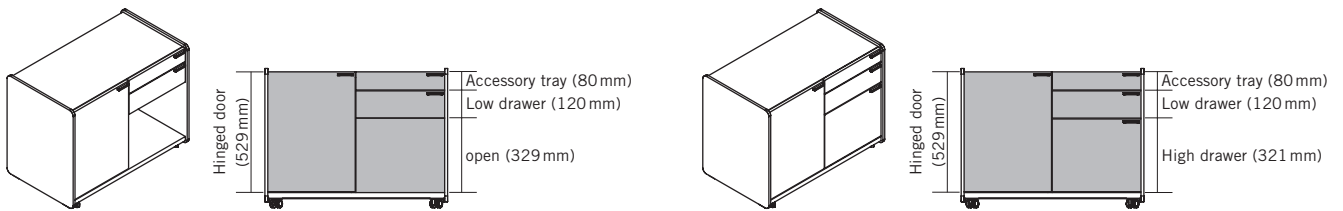

Credenza

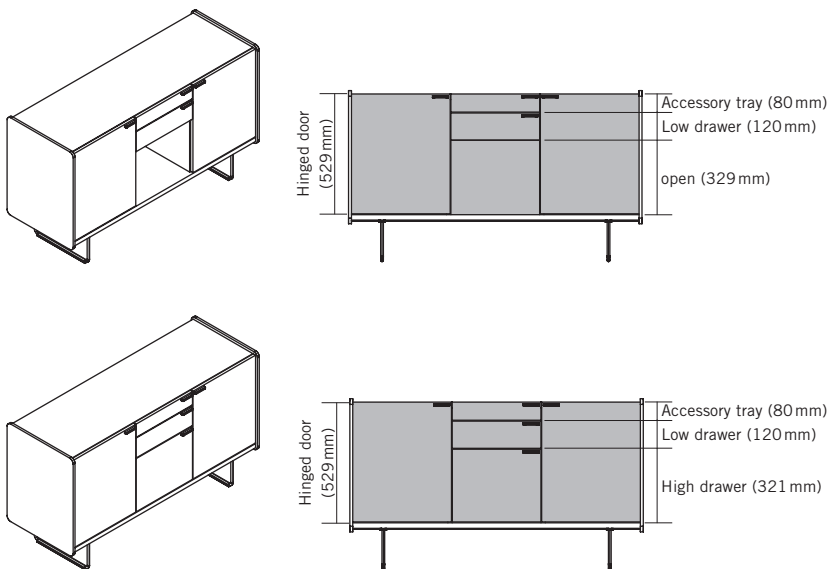

¹Hinged design (right or left) available (note accessory tray lock position).

OPTIONS

LOCK

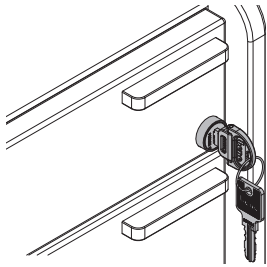

Without lock or lock hole, but with locking bar. Optional lock with changeable cylinder including two keys (one key is folding) and a locking bar.

When there is an accessory tray, the lock is always on the right.

ANTI-TIPPING PROTECTION

For the SIDE_S Caddy and the Pedestal, Sideboard or Credenza with a high drawer, anti-tipping protection is provided in the form of a counterweight.

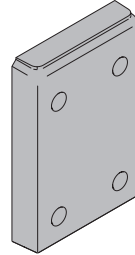

Counterweight

Concrete plate fastened to the inside of the rear wall.

TRAY

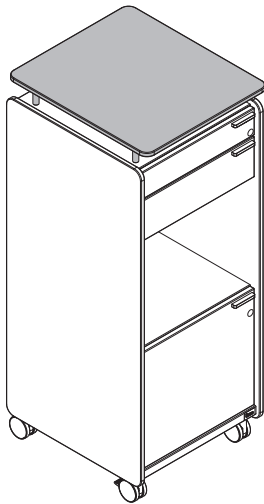

Optional for SIDE_S Caddy.
Dimension: Height 77,8 mm, width 417,6 mm and depth 480 mm

Material & colour: 12 mm birch plywood; tray surface can be selected from veneer group 1.

SUPPLEMENTARY COMPARTMENT

Optional for SIDE_S Caddy.

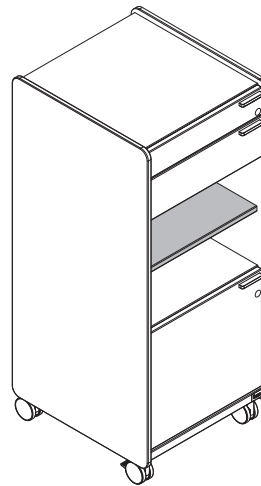

INSPIRATIONS



Inspiration #01

- Workstation with Delta by Bene, HC oak nature
- Soft Edge, 1.800x800 mm
- High RIYA with headrest
- SIDE_S Pedestal in MW white melamine/EY oak sylt veneer



Inspiration #02

- Workstation with Delta by Bene, HD oak graphite
- Soft Edge, 2.000x800 mm
- Medium-high RIYA
- SIDE_S Sideboard/Credenza in MW white melamine/EV oak volcano veneer

INSPIRATIONS



Inspiration #03

- Workbench with Delta by Bene, HC oak nature
- T-Panel Curve with gap between desk tops
- Soft Edge, 1.600x1.602 mm
- Bay Chair
- 6 SIDE_S Caddy in MW white melamine/EY oak sylt veneer

COLOURS & MATERIALS

MELAMINE: Basic colours

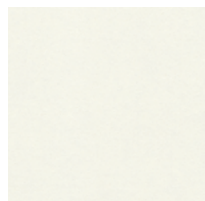

MW white

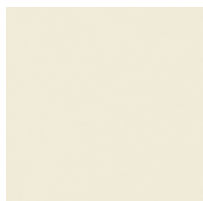

MQ office white

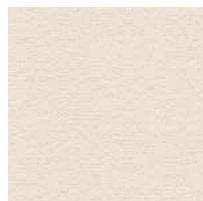

MC canvas

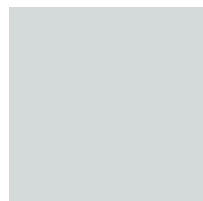

MP platinum

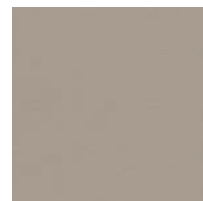

TM clay



MH stone grey

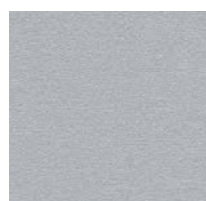

MA aluminium



MS slate

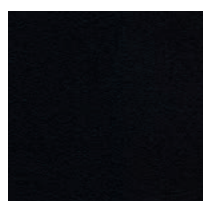

MB basalt



MD urban grey

MELAMINE: Additional basic colours

MELAMINE: Accent colours



TX mustard



TH marino blue



TS fern green

VENEER: Maple

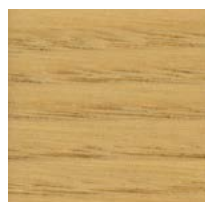

AK canadian maple

VENEER: Oak

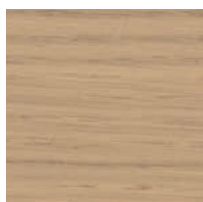

EY oak sylt

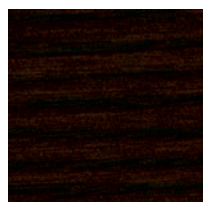

ER oak amaretto

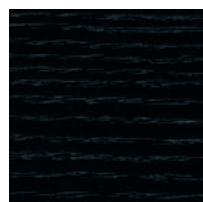

EV oak vulcano

VENEER: Chestnut

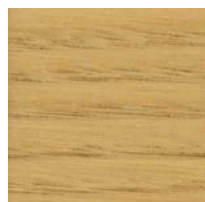

KD chestnut natural

Information

Wood is a natural product whose growth might result in colour differences and irregularities. The wood is subject to differences in structure and colour between parts of one furniture item or compared to other furniture items of the same material. As long as they remain within the nature of the materials used and are customary in trade, they do not constitute cause for a warranty claim.

To satisfy the visual standards, SIDE_S is deliberately made with plywood and may contain knots as well as cracks. These design characteristics are proof of authenticity and not a valid reason for complaint.