

# CONSULT

The elegant connection of work and discussion. CONSULT offers the perfect foundation for conveying a professional appearance: the spacious work desk system elegantly combines desk, storage and meeting area into one piece of furniture.

On one hand it is a place for focused working, while also a space for informal exchange, expert consultations and successful negotiations on the other. CONSULT conveys identity and looks inviting – making anyone feel that they are in good hands.



## PRODUCT DESCRIPTION

- ❶ **Table Top:** Three board thickness are available:  
13 mm compact top, 19 mm, or 25 mm chipboard
- ❷ **Edge (circumferential):** Chipboard 19 mm: 2 mm mono-edge, 2mm duo-edge, or 3 mm mono-edge. Chipboard 25 mm:  
2 mm mono-edge or 3 mono-edge.
- ❸ **Frame:** Slope or Circle
- ❹ **KT Sideboard**

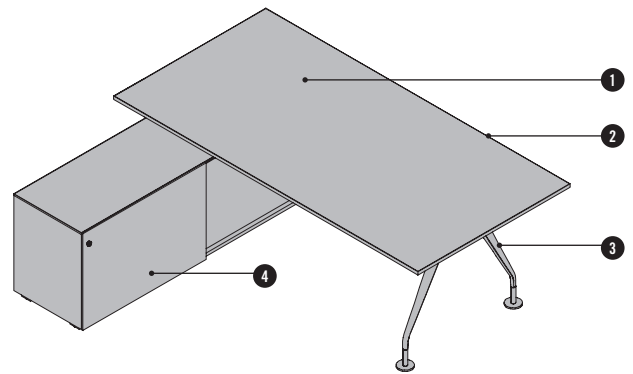

## OVERVIEW AND DIMENSIONS

### DESKTOP SHAPE TG BASIC DESK

#### Rectangle RE

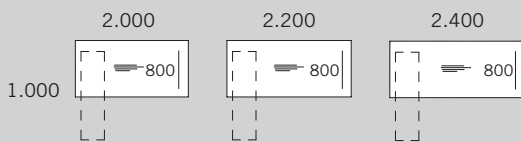

#### Rectangle RE rounded

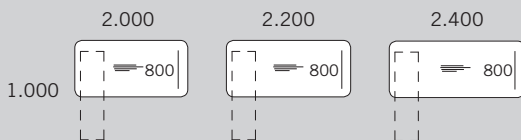

#### Cono S3

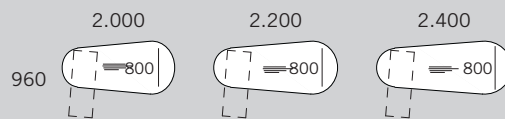

At the top shapes RE, S3 and W4 instead of the shown slab-end also the Circle is possible.

#### Angled desk 150° W4

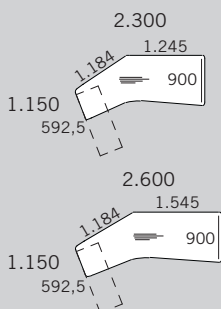

#### Angled desk 150° W5

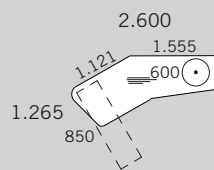

#### Angled desk 150° two-part W6

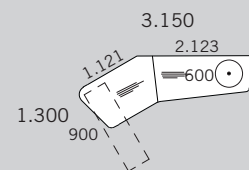

At the top shape W6 only the Circle is possible due to stability.

### LEGEND

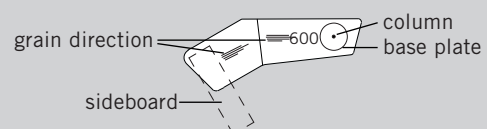
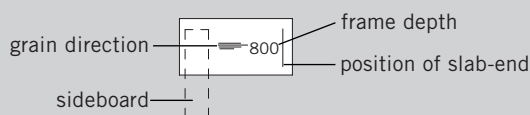

All shown top shapes in left adjustment.

Dimensions in mm

## DEFINITION OF DESK SIDES/TOP SHAPE DIRECTION

**DEFINITION OF DESK SIDES/TOP SHAPE DIRECTION**

**RE** **S3**

visitor side (B)  
left side (L) **N** right side (R)  
user side (N)

visitor side (B)  
left side (L) **L** right side (R)  
user side (N)

visitor side (B)  
left side (L) **R** right side (R)  
user side (N)

**W4, W5, W6**

visitor side (B)  
visitor side lateral (BS) lateral (S)  
front (V) **user side (N)**

visitor side (B)  
visitor side lateral (BS) front (V)  
**user side (N)**

## FRAME VERSIONS

### SLOPE

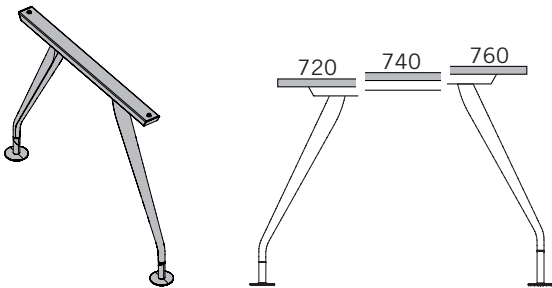

- Free-form, die casting aluminium
- Levelling: +10 mm by means of adjustment leg
- Range of height adjustment: 720/740/760 mm fixed
- Console is always in AL aluminium, coloured

### CIRCLE

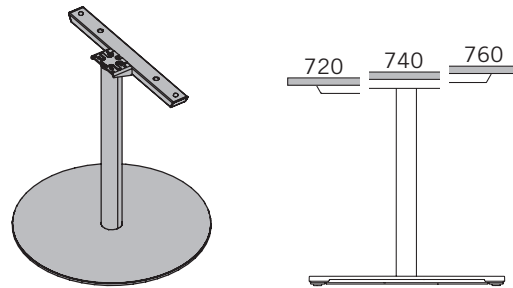

- Round pipe Ø 70 mm, smooth steel pipe
- powder-coated, sleeve anodised
- WI white, AL aluminium anodised, SZ black
- Levelling: +10 mm by means of adjustment leg
- Range of height adjustment: 720/740/760 mm fixed
- Console is always in AL aluminium, coloured

## OPTIONS

### CABLE TRAY

- quick and easy cable management under desk top
- positions are always predefined and not changeable
- colour: SZ black

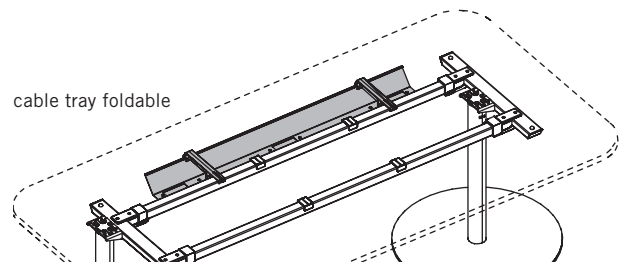

#### Possible positions of the cable tray

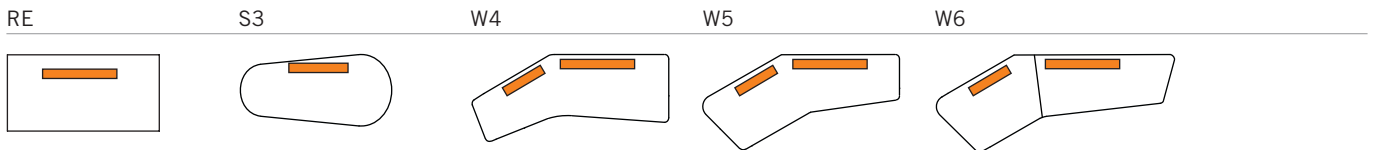

### PLUGBOX

- positions are pre-defined and not changeable
- 1 to maximum 2 plugboxes per desk top are possible
- plugbox is always integrated flush to the desk top

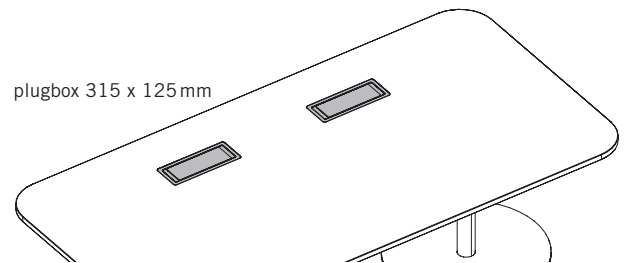

#### Possible positions of the plugbox

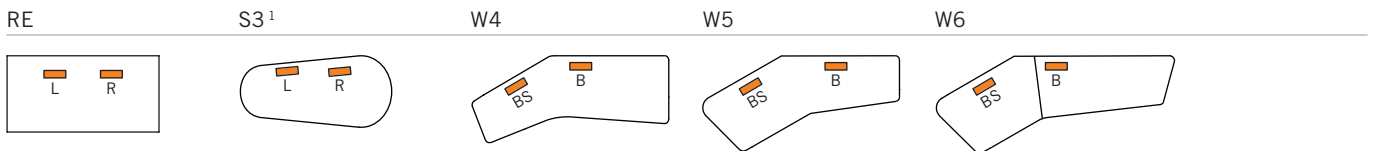

Plugbox and possible connection plug boards → pricelist cable and media management.

<sup>1</sup>Only possible at chipboard and configuration on the the deeper side only as from width 2.200 mm.

### GROMMET HOLE

- positions are pre-defined and not changeable
- 1 to maximum 3 grommet holes per desk top are possible
- colour (coloured): WI white, AL aluminium or SZ black with covering

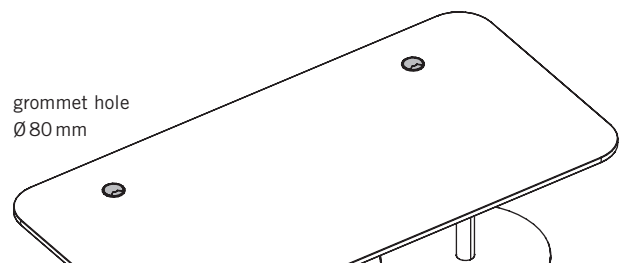

#### Possible positions of the grommet hole

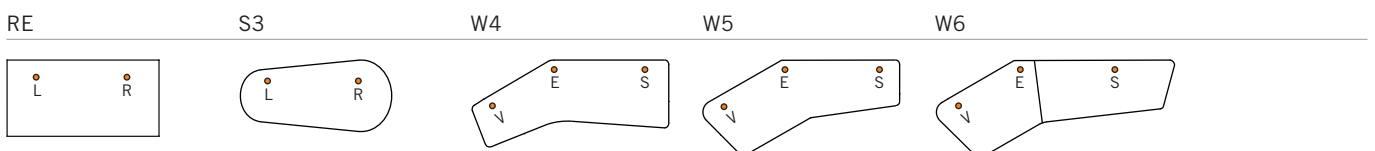

#### Designations of positions

L...left, R...right, BS...visitor side lateral, B...visitor side, V...front, E...corner, S...lateral

## OPTIONS

### PREPERATION FOR CONNECTION T-PANEL EXTEND, RV DIVIDING WALL & ACCESSORIES (UNIVERSAL ADAPTER)

- elements only at the top shapes W4, W5 and W6 possible
- fixed on univernal adapters
- number of the univernal adapters depends on top shape and top width and is always analog to the number of the top
- connection of T-Panel and shortend panels is not possible

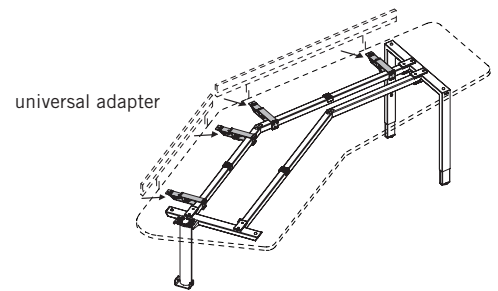

### SIDEBOARD CONNECTION

- sideboard is used as a slab-end replacement
- connection is integrated at Consult standardly
- maximum one sideboard per desk
- top shapes RE, W5, W6: min. width of the sideboard is 1.600 mm
- top shapes S3, W4: min. width of the sideboard is 1.200 mm
- desk height adjusted mechanically in 20 mm of grid (650 - 850 mm)

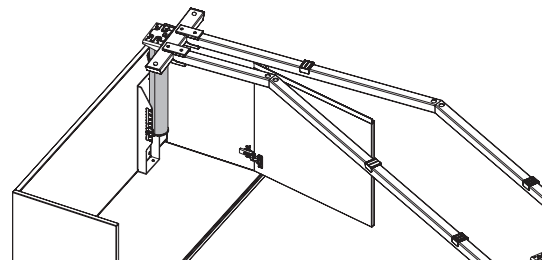

further information of sideboard → price list KT Sideboard

### Possible positions and inserting angles of the sideboard

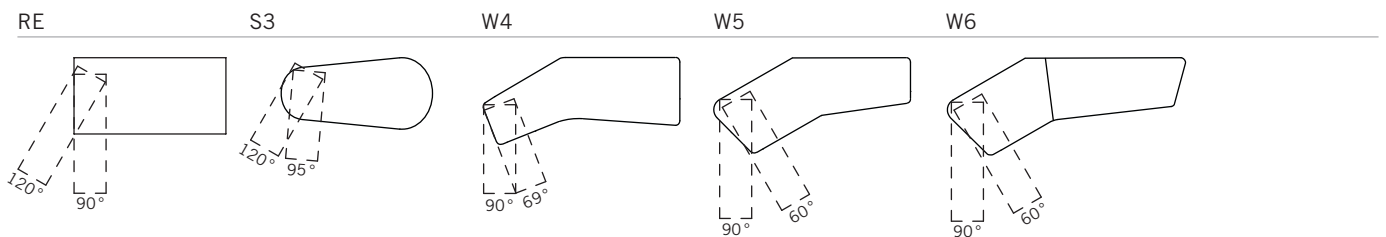

## INSPIRATIONS



### Inspiration #01

- Consult with Circle
- Angled desk 150° two-part W6, 3.150 x 1.300 mm
- Top colour: CO coco, column colour: WI white
- KT Sideboard in MW white and CO coco
- 1x B\_Run (PO) and 2x Dexter (PO)



### Inspiration #02

- Consult with Slope
- Rectangle RE, 2.000 x 1.000 mm
- Top colour: MW white, column colour: AP polished aluminium
- KT Sideboard in MW white
- 1x Bay Chair (PO)

## COLOURS & MATERIALS

### MELAMINE: Basic colours



MW white

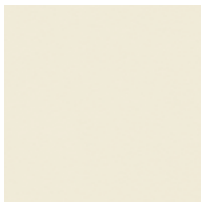

MQ office white



MC canvas<sup>3</sup>

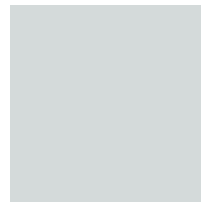

MP platinum<sup>2,3</sup>



TM clay

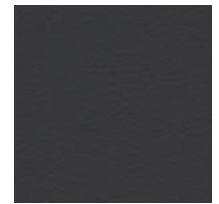

MT anthracite

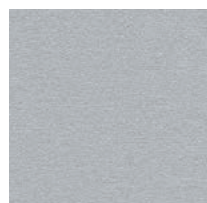

MA aluminium<sup>3</sup>

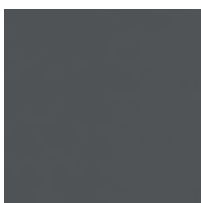

MS slate<sup>2,3</sup>

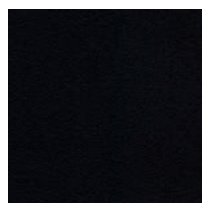

MB basalt

### MELAMINE: Additional basic colours<sup>1,2,3</sup>

### MELAMINE: Décor colours<sup>2,3</sup>

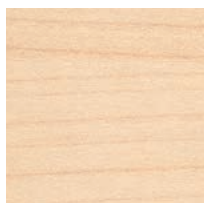

AR maple<sup>1</sup>

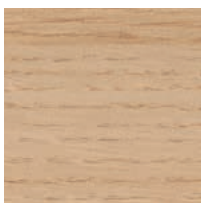

EI oak<sup>1</sup>

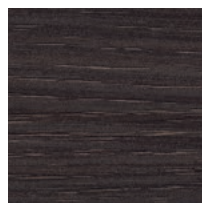

EC oak moreda

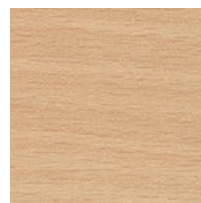

BH beech light<sup>1</sup>

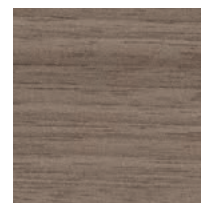

NG walnut grey

### MELAMINE: Décor colours with texture<sup>1,2,3</sup>



CE elm white



CO coco

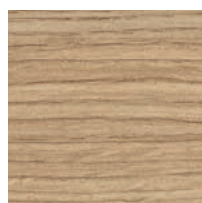

EA oak aragon

### MELAMINE: Accent colours<sup>1,2,3</sup>



TX mustard



TH marino blue



TS fern green

<sup>1</sup> not available for compact desk top

<sup>2</sup> not available for duo-edge

<sup>3</sup> not available for 3 mm edge, single colour

## COLOURS & MATERIALS

### VENEER: Maple



AK canad. maple

### VENEER: Beech



BG beech, grey

### VENEER: Oak

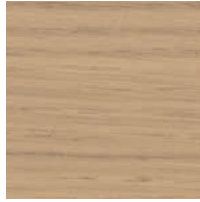

EY oak, silt

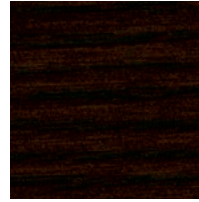

ER oak, amaretto

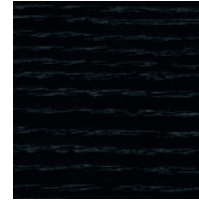

EV oak, volcano



EG oak grey

### VENEER: Chestnut



KD chestnut natural



KP chestnut brown



KQ chestnut grey

### VENEER: Walnut

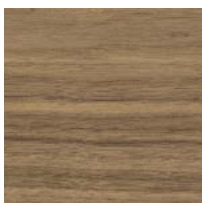

NF americ. walnut

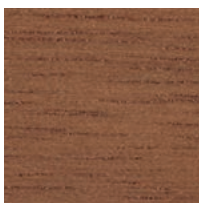

NR walnut, sienna

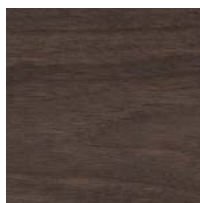

NB walnut, umbra

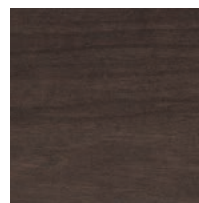

NA wal., anthracite

### VENEER: Bamboo



BJ bamboo

### METAL SURFACE POWDER-COATED

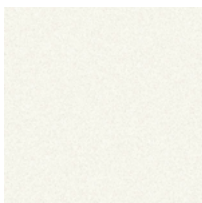

WI white

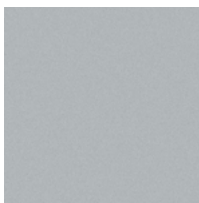

AL aluminium



SZ black

### ALUMINIUM ANODISED

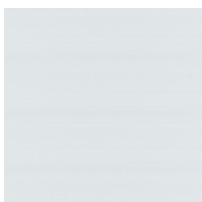

AL aluminium