

U-LIFT

ERGONOMICS AND DESIGN – THINK COMPACT

U-LIFT gives you enough space to work, concentrate and keep organised – and all in a small space. This small and practical desk not only provides storage space for the most important documents, it also offers an elegant answer to the dreaded “cable spaghetti”.

Furthermore, U-LIFT will meet your ergonomic expectations because its height can be adjusted electronically from 68 to 117 cm. This makes it possible to quickly switch between sitting and standing as needed during the day.

Design: Christian Horner



bene

INSPIRING OFFICES. SINCE 1790.

PRODUCT DESCRIPTION

- ① **Tabletop:** compact board 13 mm, 19 mm chipboard with 2 mm mono-edge or 20 mm chipboard with Fenix laminate with 1 mm edge
- ② **Power supply unit**
- ③ **Manual switch**
- ④ **Frame**
- ⑤ **Column:** steel
- ⑥ **Base plate:** steel
- ⑦ **Spiral cable:** black

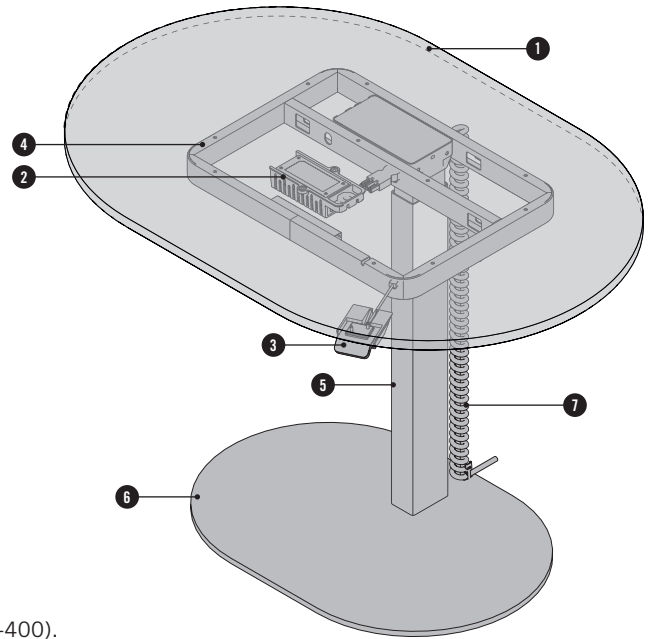

The warranty period is five years.
Covered by Bene's warranty conditions (Bene product warranty DB-ZFP-400).

OVERVIEW AND DIMENSIONS

<p>TABLETOP</p> <p style="text-align: center;">1.000</p> <p style="text-align: left;">670</p>	<p>COLUMNS powder coated steel profile pipe, rectangular: 80x50 mm</p> <p>BASE PLATE powder coated flat steel 10 mm colours: black, white, or aluminium</p>
<p>HEIGHT ADJUSTMENT</p> <p style="text-align: center;">min. 680</p> <p style="text-align: center;">max. 1.170</p>	<p>Maximum load 30 kg (all mounted and installed parts/loads must be included in the calculation)</p> <p>Two-part telescopic rectangular column with protection against uncontrolled movement</p> <ul style="list-style-type: none"> • Stroke length 495 mm • Lifting capacity 500 N • With software protection against uncontrolled movement • Control system integrated into the column; manual switch is connected directly to the column <p style="text-align: right;">Dimensions in mm</p>

PRODUCT DESCRIPTION

POWER SUPPLY UNIT SMPS006

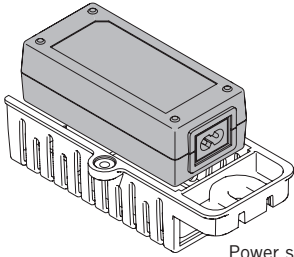

Power supply unit holder

Type

- Power supply input 100V AC to 240V AC, 50 Hz/60 Hz
- Maximum on-time 2 min. on, 18 min. off
- Protection category II
- Noise ~46 dB
- Upward lift speed 38 mm/s

Reference values for power consumption

	Load	Power consumption
· Stand-by		<0.1 watts
· Upward lift	30 kg	175 watts

MANUAL SWITCH LIGHT

Dimensions: W: 65.8 mm, H: 25.2 mm

Colour: Black

Functions: up/down function, intuitively operated element



BASIC BT MANUAL SWITCH

Dimensions: W: 65.8 mm, H: 25.2 mm

Colour: Black

Functions: up/down function, intuitively operated element, reminder function through LED diode, memory function, pedestal/shelf stop, Bluetooth®

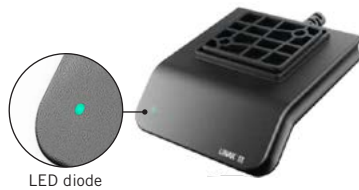

LED diode

PREMIUM BT MANUAL SWITCH

Dimensions: W: 78.8 mm, H: 25.2 mm

Colour: Black

Functions: up/down function, intuitively operated element, reminder function through LED lighting strip, memory function, pedestal/shelf stop, display, Bluetooth®



Intuitive operation

The manual switches are operated by tilting the paddle up or down, as opposed to using buttons, so that the desk can be adjusted without looking.

Motivating reminder function

The manual switches Basic BT and Premium BT have an integrated reminder function. It indicates the status of the desk usage either with a green or orange colour. When it's time to change positions, the colour changes. The intervals can be preset or customised.

Digital integration

The integrated Bluetooth® technology makes it possible to connect the manual Basic BT and Premium BT switches with the Desk Control™ app. The app is available for Android and iOS mobile devices.

OPTIONS

SCREENING ELEMENT

You can install the screening element on the left or right side. It also provides an elegant way to route charging cables and the like below the table and even makes an ideal storage place for a docking station.

- Can be installed on the left or right
- Colours: SZ black, WI white or AL aluminium coloured
- Dimensions: Width 376,5 mm, depth 376,5 mm, height 180 mm

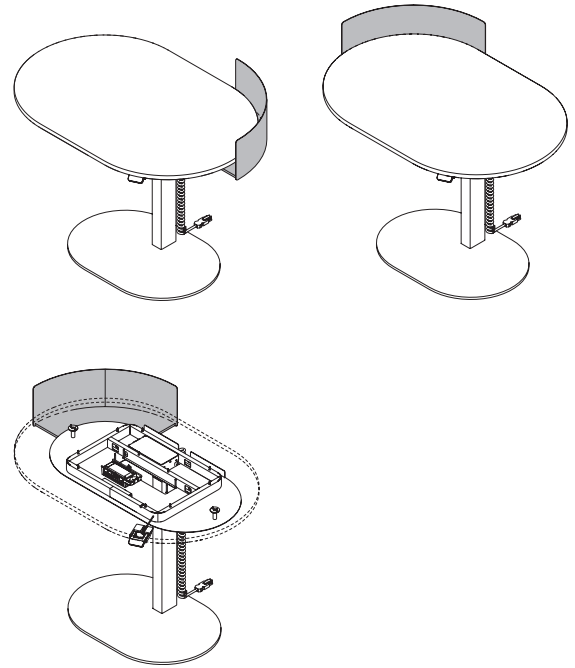

CABLE MANAGEMENT

With the U-LIFT, cables are managed in a particularly attractive manner, by means of a spiral cable (including 2 m starter cable) that supplies the column with power. This is included within the scope of delivery. It is also possible to order a 3 m or 5 m starter cable.

If desired, the table can be made ready to hold a connection plug board underneath (versions: 4x power socket or 3x power socket, 2x USB chargers).

These preparations also include a cover that conceals the electronic components and creates additional space for excess cable lengths on both the left and right. Colours: SZ black, WI white or AL aluminium coloured

Connection plug board must be ordered separately.

Connection plug boards → Price list for cable and media management

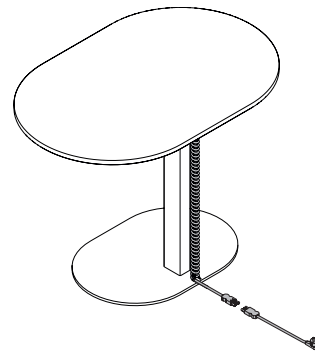

Spiral cable with 2 m starter cable

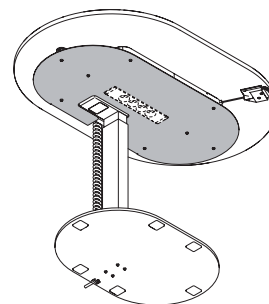

Preparation for connection plug board under the table

COLOURS & MATERIALS

MELAMINE: Basic colours



MW white

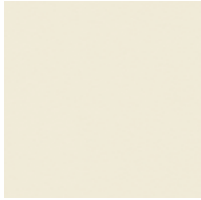

MQ office white



MC canvas

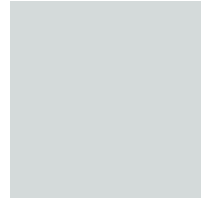

MP platinum



TM clay



MH stone grey



MA aluminium



MS slate

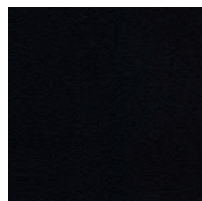

MB basalt



MD urban grey

MELAMINE: Additional basic colours

MELAMINE: Décor colours

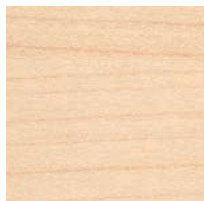

AR maple

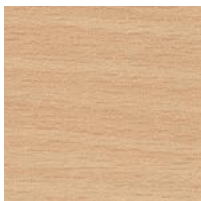

BH beech light

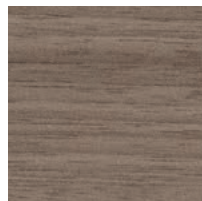

NG walnut grey



EZ oak vicenza

MELAMINE: Décor colours with texture



CE elm white



CO coco

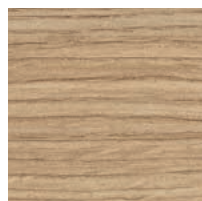

EA oak aragon

MELAMINE: Accent colours



TX mustard



TH marino blue



TS fern green

COLOURS & MATERIALS

VENEER: Maple



AK canad. maple

VENEER: Beech



BG beech, grey

VENEER: Oak



EY oak, silt

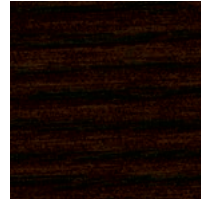

ER oak, amaretto

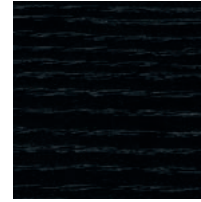

EV oak, volcano



EG oak grey

VENEER: Chestnut



KD chestnut natural



KP chestnut brown



KQ chestnut grey

VENEER: Walnut

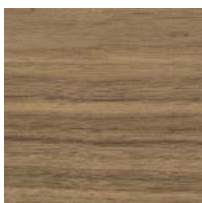

NF americ. walnut

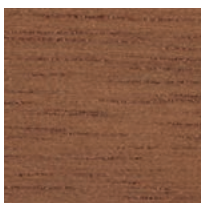

NR walnut, sienna

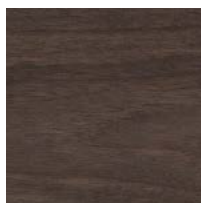

NB walnut, umbra

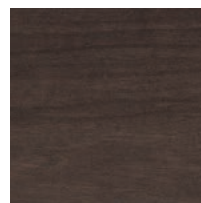

NA wal., anthracite

VENEER: Bamboo



BJ bamboo

METAL SURFACE POWDER-COATED

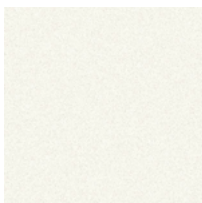

WI white

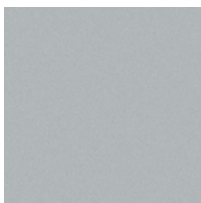

AL aluminium



SZ black

FENIX

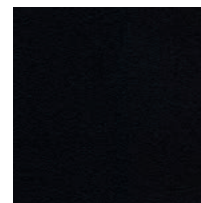

black